

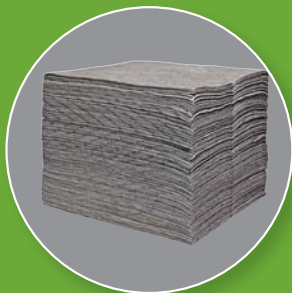

SMART SPILL SOLUTIONS.



Absorbents



Booms



Spill Kits

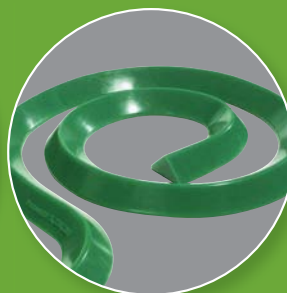

Spill Blockers



Containment



The spill response industry is always changing — and so are we!

Our engineers are constantly working to improve our existing products and develop new ones that will help your facility run more smoothly and cleanly. We are excited to share just a few of these new and improved items below.

Site visits are the most effective way for us to learn about your spill risks and discuss potential cost savings. Learn more about them on the next page.



YOU ASKED. WE LISTENED.

We heard your requests and redesigned these Smart Spill Solutions just for you!



Eco-friendly!

You asked for a mat that combines the strength of Traffic Tuff Rug with the absorbency of Recycled Tuff Rug. **Recycled Traffic Tuff Rug** does just that, plus it has the added green benefit of a 100% post-industrial recycled polyester blend construction. See **Recycled Traffic Tuff Rug** on page 57



New!

You asked us for compact, self-contained, single-use spill kits that you can take on the go. **Foil Bag Spill Kits** are packaged in a heat-sealed foil bag and packed with absorbents you need for fast spill response. Available in Universal, Oil-Only and HazMat. See **Foil Bag Spill Kits** on page 74



Redesigned!

You asked us to make **Spill Kaddie Kits** stronger and more durable. The rear step in the Kaddie's base allows you to tilt and maneuver it directly to the spill. Plus the doors open wider, making it easier to remove absorbents or refill. See **Spill Kaddie Kits** on page 67



Returning favorite!

You asked for a way to keep your drips and spills contained during routine maintenance. **Utility Trays** help keep messes off of warehouse and factory floors. Plus they're nestable for easy storage when not in use. See **Utility Trays** on page 95

Learn more about **FREE Site Visits** here



Look for this icon throughout our catalog to purchase SpillTech products made from recycled materials.



Look for the "Helps You Comply" box throughout this catalog for SpillTech Products that can assist you with regulatory compliance.

Visit spilltech.com to take advantage of excellent online resources for both customers and distributors.



Have questions or need more info?
LIVE CHAT is available 8 a.m. - 5 p.m. (ET).



- Information includes:
- Product Data Sheets
 - Safety Data Sheets
 - Chemical Compatibility Guides

Distributors who register at spilltech.com enjoy lots of extra benefits.



- You'll get:
- Order tracking
 - Invoices
 - Order history
 - Sales report card
 - Personalized price lists
 - Printable sales sheets
 - Distributor handbook

Bulletin Board Updates
inform you of product or pricing changes.



Schedule your Site Visit.

Call your SpillTech Rep to learn more and set up your Site Assessment.

They'll visit your facility to identify issues and evaluate potential cost savings. You'll be provided with:

- Recommendations to help your site operate in compliance with current OSHA and EPA standards for spill response
- An evaluation of current products to be certain they are right for the application and the most cost-effective solution for your facility
- Help to identify the best place to store your spill products for quick and effective response to any size spill
- A comprehensive final report detailing your spill risk and product suggestions — all at no cost to you!



Universal..... 6-23, 50-57

Mats	6-20, 50-57
Pillows, Socks, Booms	21-22
Pans	22
Loose.....	23
Mat Accessories	49
Floor Grabber	50-55
Tuff Rugs.....	56-57

Oil-Only..... 24-41, 58

Mats	24-36, 58
Pillows, Socks, Booms & Pans	37-39
Specialty	40
Containment Booms	41
Mat Accessories	49

HazMat 42-48

Mats	42-45
Pillows, Socks, Booms	46
Neutralizers.....	47-48
Mat Accessories.....	49

Wipers..... 59-62

Light Duty	60
Medium Duty	61
Heavy Duty	62

Spill Kits 63-84

OverPack Kits.....	64-66, 77
Wheeled & Kaddie Kits	65, 67, 70
Hi-Viz Kits	68-69
Cart Kits	70
Bag Kits.....	71-76
Specialty Kits.....	76-77
Customize Your Kit	78-79
Overpacks	80
Spill Kit Accessories.....	81-84

Spill Control 85-88

Leak Diverters	85
Barriers & Berms	86
DrainCovers & DrainPlugs.....	87
Ultra-Dewatering Bag®	88
Ultra-GutterGuard®	88
Ultra-DrainGuard®.....	88























Containment 89-101

Spill Decks & Pallets	90-92, 95
Sumps	92-93
Funnels.....	94
Portable Containment	95, 98-99
Build Your Own Berm	96-97
Containment Berms	100-101

Product SpecSheet.....	102-122
Item Number Index.....	120-122
Regulation Compliance	123

Mat Selection Guide Easily identify the best product for your needs.

Not sure what type of mat you need? Use this selection guide to narrow down your choices! You'll need to know what your primary application is and what type of liquid you want to absorb. Ratings for each mat's absorbency and durability as well as other specs are included to further aid the decision-making process.

Mat Name	CONTRACTOR GRADE	RESPONDER	DEFENDER	COMMANDER
Primary Applications	<ul style="list-style-type: none"> Economical Versatile for General Applications 	<ul style="list-style-type: none"> Marine Spills Budget-Friendly 	<ul style="list-style-type: none"> Overspray and Spills General Use 	<ul style="list-style-type: none"> Under Machines and Conveyors Walkways
Absorbency Types	 Universal  Oil Only	 Oil Only	 Universal  Oil Only  HazMat	 Universal  Oil Only  HazMat
Absorbency	●●●●○	●●●●●●	●●●●●○	●●●●●○
Durability	●●●○	●●●○	●●●○	●●●●○
Construction	Single layer of Meltblown polypropylene, dimpled for wicking power	Single layer of hydrophobic (oil-only) polypropylene	One layer of Spunbond fabric is ultrasonically bonded to a single layer of Meltblown sorbent	Two layers of Fine Fiber polypropylene are ultrasonically bonded around a high-loft Meltblown core
Available in				
Pages	 6-7,  24-25	 26-27	 8-9,  28-29,  42-43	 10-11,  30-31,  44-45

Specialty Mats



FLOOR GRABBER Pgs 52-55
This safe-floor solution sticks tight and flat to the floor where you want it and helps prevent slip and fall accidents throughout your facility.



RIG MATS Pg 58
Oil-only mat is ideal for service rigs, sucker rod maintenance, wellhead maintenance, cleaner drilling and clean compressor houses.



TUFF RUG Pg 56
Tough StitchBonded mat handles heavy wear and foot traffic. Stands up to heavy abuse — leave down much longer than regular mat and save money.



DRUM TOP Pgs 19, 36
Absorb drips from leaking pumps and help keep drum storage areas looking good. Pre-cut bung holes make for easy access to drum.



TRAFFIC TUFF RUG Pg 56
Super-durable Needle-punch mat even stands up to equipment traffic. Absorbs light fluids and overspray to keep walkways safe and slip-resistant.























SURVIVOR Pg 18
Camouflage pattern makes leaks and drips disappear. Hides the grunge to stay on the job longer. Features our toughest SpunBond top layer.

 **UNIVERSAL**
Hydraulic Oil, Ethanol, Gasoline, Kerosene, Water, Mineral Spirits, Turpentine

 **OIL ONLY**
Motor Oil, Hydraulic Oil, Gasoline, Diesel Fuel, Jet Fuel

 **HAZMAT**
Acetone, Toluene, Styrene, MEK (Methyl Ethyl Ketone), Hydrochloric Acid

PROTECTOR	ARRESTOR	TRANSFORMER	CAUTION	MAXIMIZER
<ul style="list-style-type: none"> Oily Tools and Parts Demanding Environments 	<ul style="list-style-type: none"> Use Where Static is a Problem Designed for Walkways 	<ul style="list-style-type: none"> Use as Mat, Roll, Pad and Sock Aviation and Utility Industries 	<ul style="list-style-type: none"> Safety-Focused Good for Walkways 	<ul style="list-style-type: none"> Highly Absorbent Environmentally-Friendly
 Universal Oil Only  	 Oil Only  	 Universal Oil Only  	 Universal  	 Universal  
High-loft Meltblown sorbent is ultrasonically bonded between two layers of lint-free Spunbond fabric	Single-layer polypropylene	Spunbond top layer, Meltblown core and Fine Fiber bottom layer, all ultrasonically bonded together	Top Spunbond and bottom Fine Fiber layers of polypropylene are ultrasonically bonded around a Meltblown core	Super-absorbent core fuses natural and synthetic fibers to enhance absorbency, strength and loft
				
12-13, 32-33	34	19, 35	14-15	16-17

Selecting the right SpillTech Mat for your needs



Determine the TYPE of liquids being absorbed:



Universal –

For oil- or water-based liquids (oils, coolants, solvents and water)



Oil Only –

For oils and oil-based liquids, not water (oil, diesel, gas, petroleum and fuels)



HazMat –

For chemicals and unknown liquids (acids, bases)



Determine the AMOUNT of liquid being absorbed:



LightWeight –

Small spill or slow drip



MediumWeight –

Consistent leak or drip, medium spill



HeavyWeight –

Flowing leak or drip, large spill



Consider the APPLICATION:

- Small leaks or drips:**
Choose a 1- or 2- ply absorbent
- Larger spills, wiping or the presence of foot traffic:**
Choose a more durable 3-ply absorbent
- Abrasive tasks:**
Choose an absorbent with a spunbond top layer to reduce linting or tearing
- Mat construction**
Check out the TechSpec on each mat presentation for details about mat construction

CONTRACTOR GRADE

The economical choice for quick, easy cleanup.

UNIVERSAL ABSORBENCY: Oil, coolants, solvents & water

APPLICATION: General applications, economical

DURABILITY: ●●●○

ABSORBENCY: ●●●●○

AVAILABLE IN: 

CONTRACTOR GRADE

MAT CONSTRUCTION

Single layer of Meltblown polypropylene, dimpled for wicking power.

Meltblown

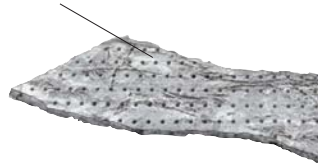

FEATURES AND BENEFITS

- Universal absorbency — used for both oil-and water-based liquids
- Perforations allow you to use only what you need
- Dimples add fast-wicking power
- Quickly absorbs leaks, spills and overspray to keep floors dry
- Perfect for light-duty industrial, maintenance and general applications
- Pads are ideal for catching leaks and soaking up spills; rolls are great for covering large surface areas
- Pads perforated at 7.5" up the center; rip off only what you need
- Rolls perforated every 7.5" vertically and cross-perforated at 17" horizontally so you can use less and save money

HYC

Helps you comply with 29 CFR 1910.22(a)(2), 29 CFR 1910.120(j)(1), 29 CFR 1910.1450(e), 29 CFR 1910.107(b)(3), 49 CFR 173.12 (b)(2)(iv) and 29 CFR 1910.107(g)(2). See page 123 for details.

- Economical
- Perfect for General Applications
- Fast-Wicking



Light-duty cleanup



Budget Friendly Basics.

Part of making smart spill decisions is not buying more absorbent than you need. Not every job requires long-term durability or heavy-duty strength. Sometimes you need an absorbent that will let you get in, do the job, and get out. These absorbents are versatile enough to use for just about any challenge that pops up on your job site.

Smart Selection Tip:

Look for the Contractor Grade Symbol and save.

SpillTech's economical line of absorbents also come in Oil-Only Pads and Rolls (page 24-25) and Booms (page 39).



Small spills

CONTRACTOR GRADE Gray Universal Pads

Item #	Description	Size	Units/Pkg	Absorbs/Pkg
GP-H	HeavyWeight Pads	15" X 18"	100	22 gal.
GP-M	MediumWeight Pads	15" X 18"	100	20 gal.
GP-S	LightWeight Pads	15" X 18"	200	35 gal.

CONTRACTOR GRADE Gray Universal Rolls

Item #	Description	Size	Units/Pkg	Absorbs/Pkg
GR-H	HeavyWeight Roll	30" X 150'	1	44 gal.
GR-M	MediumWeight Roll	30" X 150'	1	40 gal.



GP-H



GP-S



GR-H



GR-M



- **Everyday Use**
- **Absorbs on Contact**
- **Perforated for Your Needs**

DEFENDER

General-Purpose SonicBonded mat for overspray and everyday use.

UNIVERSAL ABSORBENCY: Oil, coolants, solvents & water

APPLICATION: Overspray and Spills, General Use

DURABILITY: ● ● ● ○ ○

ABSORBENCY: ● ● ● ● ○

AVAILABLE IN: 

FEATURES AND BENEFITS

- Abrasion-resistant top layer gives pads and rolls strength for everyday cleanup jobs
- Perfect for medium-duty industrial, maintenance and general applications
- Quickly absorbs leaks, spills and overspray to keep floors dry
- Perforations allow you to tear pads and rolls into different sizes based on your application
- Universal absorbency means one product for multiple liquids
- Pads perforated at 7.5" up the center
- Rolls perforated every 7.5" vertically and cross-perforated at 17" horizontally

DEFENDER

MAT CONSTRUCTION

One layer of spunbond fabric is ultrasonically bonded to one layer of meltblown sorbent.

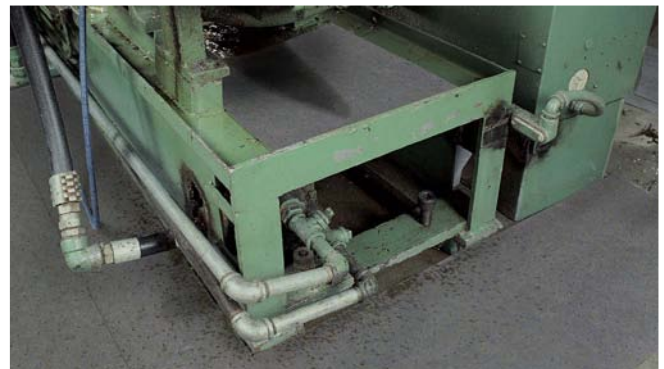
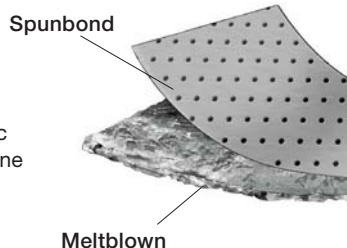

Fast-acting DEFENDER Mat starts absorbing on contact. It's the best choice for overspray and soaking up spills.

HYC

Helps you comply with 29 CFR 1910.22(a)(2), 29 CFR 1910.107(b)(3), 29 CFR 1910.107(g)(2), 29 CFR 1910.120(j)(1), 29 CFR 1910.1450(e), and 49 CFR 173.12 (b)(2)(iv). See page 123 for details.



Smart Selection Tip:

Save on time and labor with sorbent mats.



Based on a 30 gal spill:

CLAY	POLYPROPYLENE
PRODUCT NEEDS:	
8 bags (\$40)	1 package (\$68)
DISPOSAL CONTAINERS:	
2 drums (\$150)	1 drum (\$75)
LABOR & TIME	
3 people X 2 hr (\$90)	1 person X 1 hr (\$15)
MATERIALS	
3 brooms, 3 pans (\$150)	2 Hands (\$0)
DISPOSAL	
2 drums (\$550)	1 drum (\$275)
TOTALS	
\$935	\$433

DEFENDER™ Gray Universal Pads

Item #	Description	Size	Units/Pkg	Absorbs/Pkg
GPB100H	HeavyWeight Pads	15" x 19"	100	29.1 gal.
GPB50H	HeavyWeight Pads	15" x 19"	50	14.6 gal.
GPKB50H	HeavyWeight King Pads	30" x 30"	50	45.3 gal.
NEW GPB50M	MediumWeight Pads	15" x 19"	50	12.3 gal.
GPB100M	MediumWeight Pads	15" x 19"	100	24.7 gal.
GPB200S	LightWeight Pads	15" x 19"	200	31.1 gal.
GPB100S	LightWeight Pads	15" x 19"	100	15.6 gal.



GPB100H



GPKB50H

DEFENDER™ Gray Universal Rolls

Item #	Description	Size	Units/Pkg	Absorbs/Pkg
GRB150H	HeavyWeight Roll	30" x 150'	1	55.2 gal.
GRSB150H	HeavyWeight Split Rolls	15" x 150'	2	55.2 gal.
GRB150M	MediumWeight Roll	30" x 150'	1	46.1 gal.
GRB300S	LightWeight Roll	30" x 300'	1	59.1 gal.



GRB150M



GRSB150H



COMMANDER

Durable Fine Fiber mat performs all around the workplace.

UNIVERSAL ABSORBENCY: Oil, coolants, solvents & water

APPLICATION: Moderate Foot Traffic, All-Around Performer

DURABILITY: ●●●●○

ABSORBENCY: ●●●●○

AVAILABLE IN:

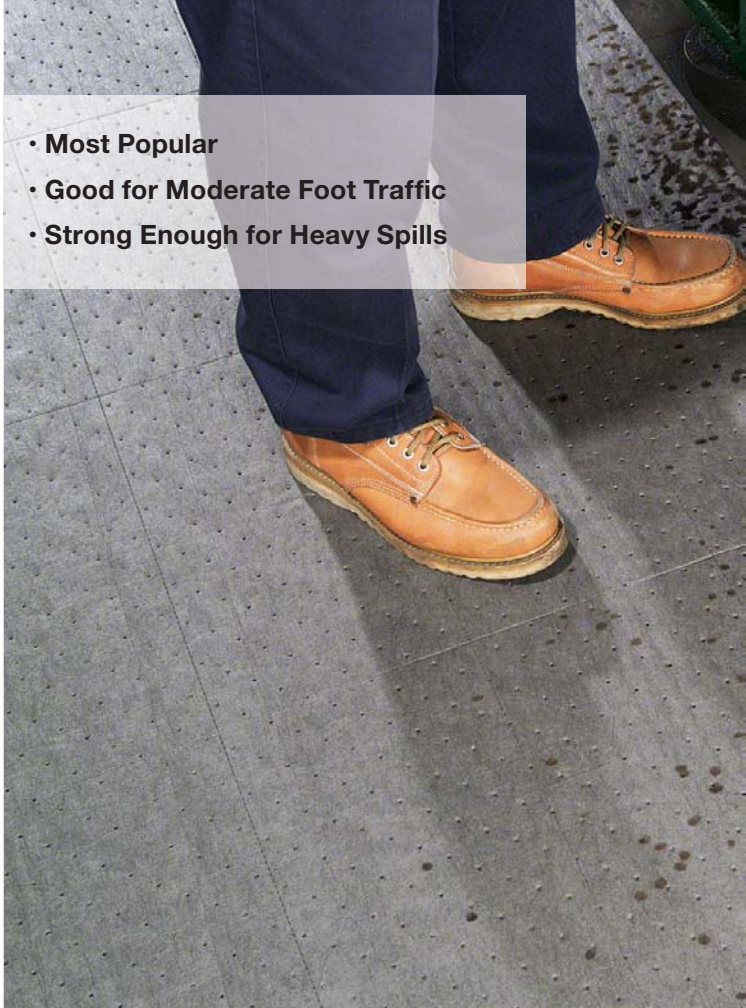

- Most Popular
- Good for Moderate Foot Traffic
- Strong Enough for Heavy Spills

COMMANDER

MAT CONSTRUCTION

Two layers of Fine Fiber polypropylene are ultrasonically bonded around a high-loft meltblown core.

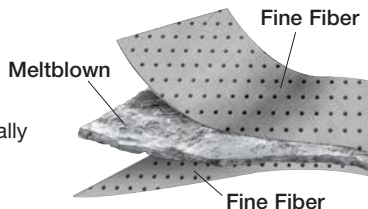

FEATURES AND BENEFITS

- Most versatile mat used in industries with wet processes
- Best used around machinery, in production areas and under assembly lines and conveyors
- Pads perforated at 7.5" up the center
- Rolls perforated every 7.5" vertically and cross-perforated at 17" horizontally

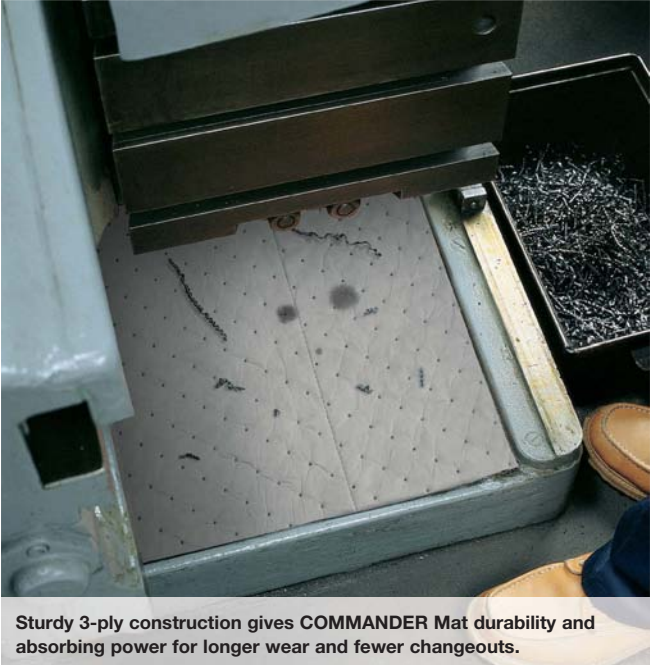

Sturdy 3-ply construction gives COMMANDER Mat durability and absorbing power for longer wear and fewer changeouts.

HYC Helps you comply with 29 CFR 1910.22(a)(2), 29 CFR 1910.107(b)(3), 29 CFR 1910.107(g)(2), 29 CFR 1910.120(j)(1), 29 CFR 1910.1450(e) and 49 CFR 173.12 (b)(2)(iv). See page 123 for details.

WANT SMOOTH, EASY ROLL DISPENSING?
See our RollRacks - Page 49



A Top Pick for Quality and Versatility.

SpillTech's most popular mat combines high absorbency with a durability suited for walkways, catwalks and foot traffic where there's overspray.

MATCH THE MAT TO YOUR ENVIRONMENT.

- Green color blends in to more professional settings, such as a medical environment
- 3-ply construction is strong and absorbent to take command of leaks and spills

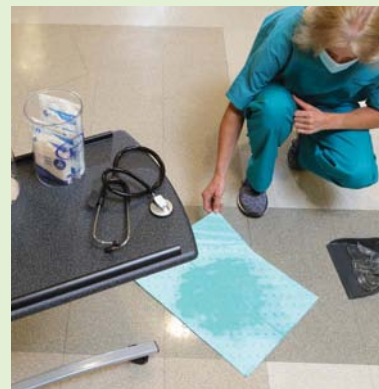

COMMANDER™ Green Universal Pads

Item #	Description	Size	Units/Pkg	Absorbs/Pkg
GNPF100H	HeavyWeight Pads	15" x 19"	100	26.3 gal.
GNPF100H-BX	HeavyWeight Pads in Dispenser Box	15" x 19"	100	26.3 gal.
GNPF100M	MediumWeight Pads	15" x 19"	100	20.8 gal.

COMMANDER™ Green Universal Rolls

Item #	Description	Size	Units/Pkg	Absorbs/Pkg
GNRF150H	HeavyWeight Roll	30" x 150'	1	49.8 gal.
GNRSF150H	HeavyWeight Split Rolls	15" x 150'	2	49.8 gal.

COMMANDER™ Gray Universal Pads

Item #	Description	Size	Units/Pkg	Absorbs/Pkg
GPF100H	HeavyWeight Pads	15" x 19"	100	26.3 gal.
GPF1014H	HeavyWeight Pads	10" x 14"	100	18.1 gal.
GPF100H-BX	HeavyWeight Pads in Dispenser Box	15" x 19"	100	26.3 gal.
GPKF50H	HeavyWeight King Pads	30" x 30"	50	41.6 gal.
GPF100M	MediumWeight Pads	15" x 19"	100	20.8 gal.
GPF200S	LightWeight Pads	15" x 19"	200	28.1 gal.

Drip, Rip and Go™ Gray Universal Tablet

Item #	Description	Size	Units/Pkg	Absorbs/Pkg
GPF20S	LightWeight Pads	15" x 19"	20 pads/tablet 9 tablets/pkg	25.2 gal.

COMMANDER™ Gray Universal Rolls

Item #	Description	Size	Units/Pkg	Absorbs/Pkg
GRF150H	HeavyWeight Roll	30" x 150'	1	49.8 gal.
GRF24150H	HeavyWeight Roll	24" x 150'	1	39.8 gal.
GRF100H-BX	HeavyWeight Roll in Dispenser Box	15" x 100'	1	19.3 gal.
GRSF150H	HeavyWeight Split Rolls	15" x 150'	2	49.8 gal.
GRFF50H	HeavyWeight Folded Roll in Dispenser Box	5" x 50'	1	8.4 gal.
GRF150M	MediumWeight Roll	30" x 150'	1	39.5 gal.
GRSF150M	MediumWeight Split Rolls	15" x 150'	2	39.5 gal.
GRF300S	LightWeight Roll	30" x 300'	1	53.4 gal.
GRSF300S	LightWeight Split Rolls	15" x 300'	2	53.4 gal.
GRSF1550S	LightWeight Mini Rolls	15" x 50'	12	53.4 gal.



GPF100H



GPF20S



GRSF1550S
(Read more on pg 20)



GRF100H-BX



- Durable for Rugged Applications
- Great for Cleaning Oily Tools and Parts
- Low-Lint

PROTECTOR

Tough MultiLaminate mat stands up to punishing applications.

- ▶ **UNIVERSAL ABSORBENCY:** Oil, coolants, solvents & water
- ▶ **APPLICATION:** Demanding Environments, Low Linting
- ▶ **DURABILITY:** ●●●●●
- ▶ **ABSORBENCY:** ●●●●○
- ▶ **AVAILABLE IN:**

FEATURES AND BENEFITS

- Abrasion-resistant outer layers of Spunbond material add durability for long life
- Low-linting mat is a great choice for lining tool benches, wiping down machinery or cleaning oily tools and parts
- Perfect for industrial applications in demanding environments where durability is most important
- Perforations allow you to tear pads and rolls into different sizes based on your application
- Pads perforated at 7.5" up the center
- Rolls perforated every 7.5" vertically and cross-perforated at 17" horizontally

PROTECTOR

MAT CONSTRUCTION

Meltblown sorbent is ultrasonically bonded between two layers of lint-free spunbond fabric.

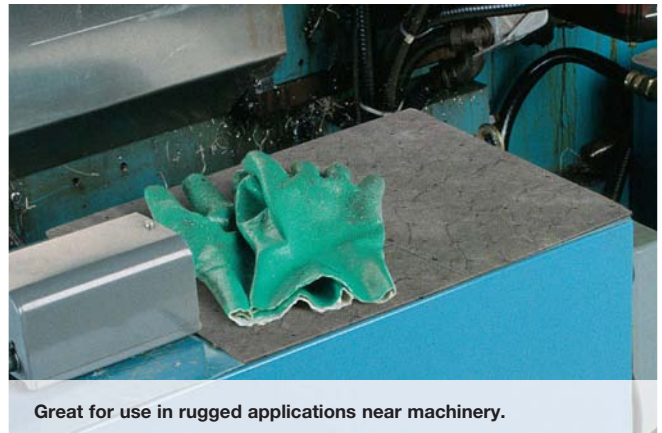
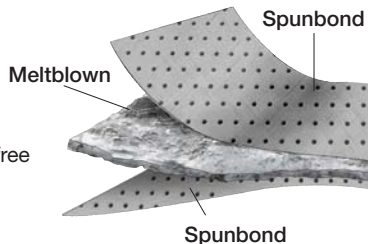

Great for use in rugged applications near machinery.

HYC Helps you comply with 29 CFR 1910.22(a)(2), 29 CFR 1910.120(j)(1), 29 CFR 1910.1450(e) and 49 CFR 173.12 (b)(2) (iv). See page 123 for details.



Smart Selection Tip:

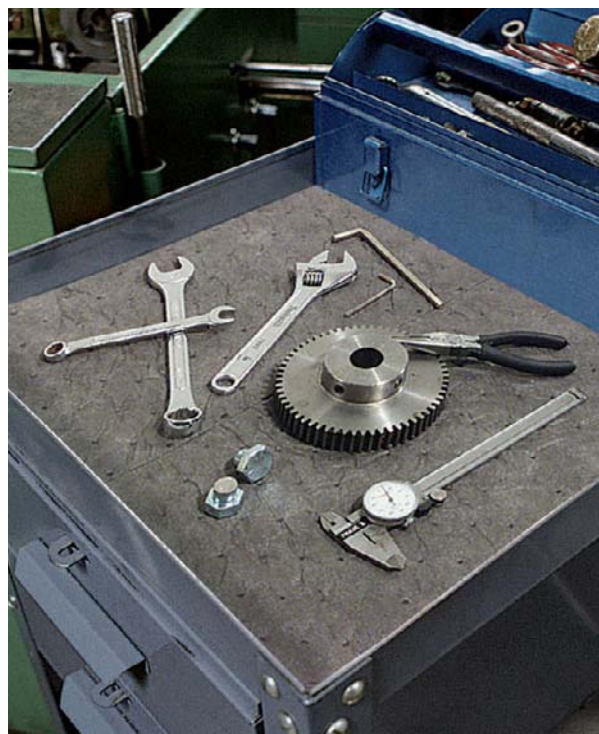

Put your tools out to dry.

What do you do with wet, dripping tools after a cleaning bath? Try placing them on low-linting Protector mat to dry. Once they're done dripping, use the mat to give them a final wipe before putting them away.

PROTECTOR™ Gray Universal Pads

Item #	Description	Size	Units/Pkg	Absorbs/Pkg
GPL100H	HeavyWeight Pads	15" x 19"	100	28.9 gal.
GPL100M	MediumWeight Pads	15" x 19"	100	23.4 gal.

PROTECTOR™ Gray Universal Rolls

Item #	Description	Size	Units/Pkg	Absorbs/Pkg
GRL150H	HeavyWeight Roll	30" x 150'	1	54.9 gal.
GRSL150H	HeavyWeight Split Rolls	15" x 150'	2	54.9 gal.
GRL150M	MediumWeight Roll	30" x 150'	1	44.4 gal.
GRSL150M	MediumWeight Split Rolls	15" x 150'	2	44.4 gal.



GPL100H



GPL100M



GRL150H



GRSL150H

CAUTION

Alert workers to potential safety hazards and work in progress while keeping floors dry.

UNIVERSAL ABSORBENCY: Oil, coolants, solvents & water

APPLICATION: Safety, everyday cleanup

DURABILITY: ●●●●●

ABSORBENCY: ●●●●○

AVAILABLE IN: 

CAUTION

MAT CONSTRUCTION

Top spunbond and bottom Fine Fiber layers of polypropylene are ultrasonically bonded around a meltblown core.

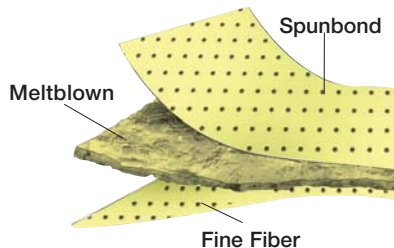

FEATURES AND BENEFITS

- High-visibility mat design features multilingual safety messages and symbols to alert workers about potential workplace hazards
- Abrasion-resistant top layer gives pads strength for everyday cleanup jobs
- Universal absorbency means one product for multiple liquids
- Quickly absorbs leaks, spills and overspray to keep floors dry

- Safety-Focused
- Everyday Cleanup
- Good for Walkways
- Effective in Production Areas

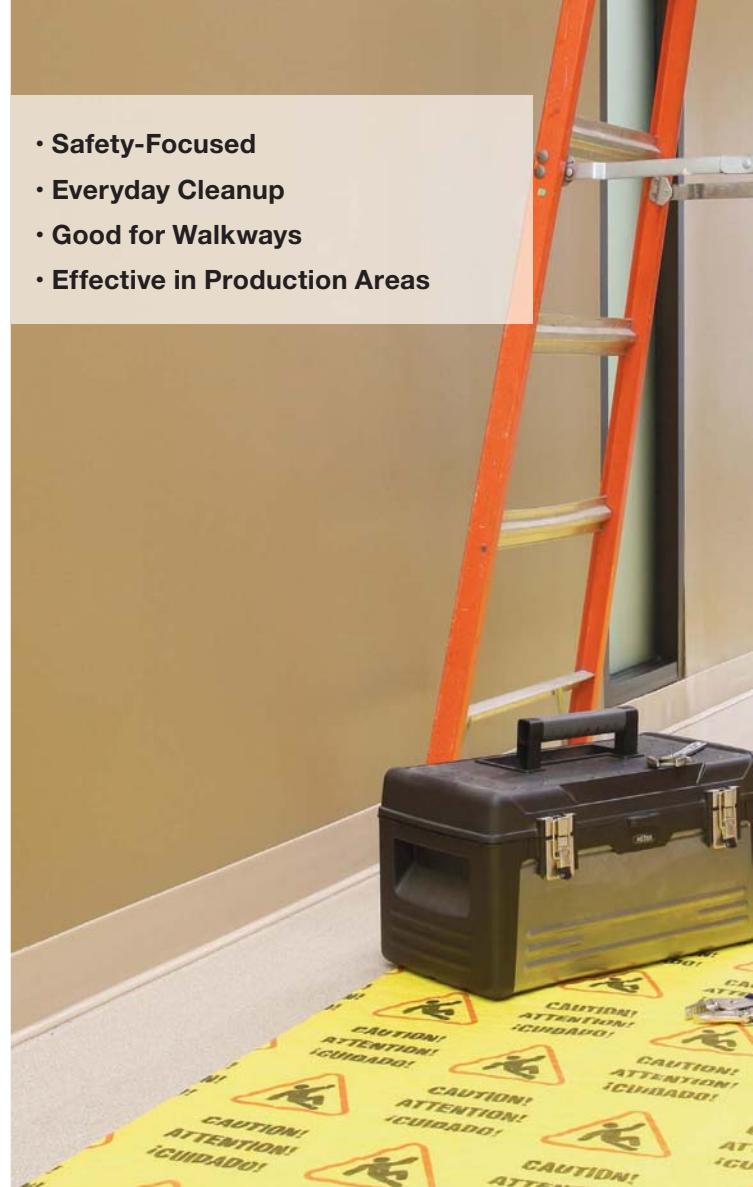

HYC

Helps you comply with 29 CFR 1910.120(j)(1), 29 CFR 1910.1450(e), 40 CFR 263.31 and 49 CFR 173.3(c)(2). See page 123 for details.



Message Received.

Make sure your safety warnings come through loud and clear.



Smart Selection Tip:



A CLOSER LOOK AT CAUTION MAT

Safety messages in three languages plus visual safety symbols communicate a clear message to customers and employees.



Alert your workers to potential hazards and absorb leaks until you're able to make repairs.

CAUTION Yellow Universal Pads

Item #	Description	Size	Units/Pkg	Absorbs/Pkg
YPZ100H-BX	HeavyWeight Pads	15" x 19"	100	29.1 gal.
YPZ100M-BX	MediumWeight Pads	15" x 19"	100	24.7 gal.
YPZ200S-BX	LightWeight Pads	15" x 19"	200	31.1 gal.
YPZ25S-BX	LightWeight Pads	15" x 19"	25 pads/box 5 box/ pkg.	19.4 gal.
YPZ100S-BX	LightWeight Pads	15" x 19"	100	15.6 gal.

CAUTION Yellow Universal Rolls

Item #	Description	Size	Units/Pkg	Absorbs/Pkg
YRZ150H	HeavyWeight Roll	30" x 150'	1	55.2 gal.
YRZ100H-BX	HeavyWeight Roll	15" x 100'	1	18.9 gal.
YRSZ150H	HeavyWeight Split Rolls	15" x 150'	2	55.2 gal.
YRZ150M	MediumWeight Roll	30" x 150'	1	46.1 gal.
YRSZ150M	MediumWeight Split Rolls	15" x 150'	2	46.1 gal.
YRSZ150M-1	MediumWeight Roll	15" x 150'	1	23.0 gal.
YRZ300M	MediumWeight Roll	30" x 300'	1	92.2 gal.



YPZ100M-BX



YPZ25S-BX



YRZ100H-BX



YRSZ150M-1



- Great for Large Leaks and Spills
- Highly Absorbent
- Environmentally-Friendly

MAXIMIZER

Get tremendous absorbency with our thickest, most absorbent mat.

- ▶ **UNIVERSAL ABSORBENCY:** Oil, coolants, solvents & water
- ▶ **APPLICATION:** High-volume leaks and spills
- ▶ **DURABILITY:** ● ● ● ○ ○
- ▶ **ABSORBENCY:** ● ● ● ● ●
- ▶ **AVAILABLE IN:**

FEATURES AND BENEFITS

- Highest absorbency for everyday applications; takes in up to 14X its own weight in liquids
- Absorbs oils, coolants, solvents and water
- Mat absorbs evenly throughout for superior liquid retention
- Contains 75% recycled fibers, making it a great choice when environmentally-friendly products are desired
- Maximizer mats are fire retardant for added safety
- Pads are ideal for catching leaks and soaking up spills
- Rolls are great for covering large surface areas, with perforations that allow you to create different sizes
- Pads are perforated at 7.5" up the center. Rolls are perforated every 15" vertically and cross-perforated at every 19" horizontally

MAXIMIZER

MAT CONSTRUCTION

Super-absorbent core fuses natural and synthetic fibers to enhance absorbency, strength and loft.

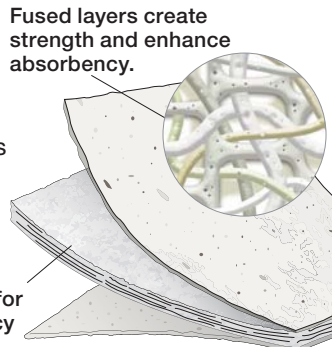

HYC Helps you comply with 29 CFR 1910.22(a)(2) . See page 123 for details.



Smart Selection Tip:



ABSORBS 14X ITS OWN WEIGHT!
 SpillTech's Maximizer absorbents are designed especially for large spills and high-volume leaks. The superabsorbent high-loft core is strong enough to hold together, even when fully saturated.



MAXIMUM LOFT



MAXIMUM ABSORBENCY



MAXIMUM PERFORMANCE

MAXIMIZER Universal Pads

Item #	Description	Size	Units/Pkg	Absorbs/Pkg
GPC75H	HeavyWeight Pads	15" x 19"	75	27.5 gal.
GPC100S	LightWeight Pads	15" x 19"	100	24 gal.

MAXIMIZER Universal Rolls

Item #	Description	Size	Units/Pkg	Absorbs/Pkg
GRC150H	HeavyWeight Roll	30" X 150'	1	69 gal./pkg.
GRC150S	LightWeight Roll	30" X 150'	1	44 gal./pkg.



SpillTech



GPC75H



GPC100S



SpillTech



GRC150H



GRC150S



SURVIVOR

The absorbency of a mat and the durability of a rug — hides the grunge to stay on the job longer.

- Camouflage pattern makes leaks and drips disappear
- Five-star durability withstands foot traffic in production areas, near machines and in walkways
- Innovative 3-ply construction combines our toughest SpunBond top layer, highly absorbent core and a bottom layer designed to grip floors
- Perforations allow you to tear pads and rolls into different sizes based on your application

SURVIVOR

MAT CONSTRUCTION

Top SpunBond and bottom Fine Fiber layers of polypropylene are ultrasonically bonded around a MeltBlown core.

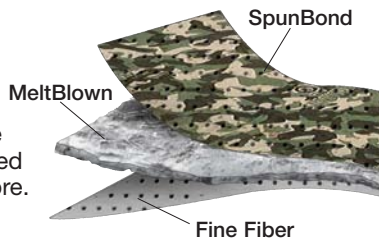

HYC

Helps you comply with 29 CFR 1910.107(g)(2), 29 CFR 1910.107(b)(3), 29 CFR 1910.22(a)(2), 29 CFR 1910.120(j)(1), 29 CFR 1910.1450(e), 49 CFR 173.12 (b)(2)(iv). See page 123 for details.

SURVIVOR™ Universal Pads

Item #	Description	Size	Units/Pkg	Absorbs/Pkg
SVP100H	HeavyWeight Pads	15" x 19"	100	17.9 gal.

SURVIVOR™ Universal Rolls

Item #	Description	Size	Units/Pkg	Absorbs/Pkg
SVR150H	HeavyWeight Roll	30" x 150'	1	35.8 gal.
SVRS150H-1	HeavyWeight Roll	15" x 150'	1	17.9 gal.
SVRS150H-2	HeavyWeight Split Rolls	15" x 150'	2	35.8 gal.



SVP100H



SVR150H



TRANSFORMER

Versatile mat is a roll, a pad and a sock.

- Perfed 3.75" vertically and 17" horizontally to tailor the mat to your application — trifold a pad into a sock in no time
- Durable, 3-layer construction keeps the mat on the job longer
- Packaged in a convenient dispenser box



HYC Helps you comply with 29 CFR 1910.22(a)(2), 29 CFR 1910.107(g)(2), 29 CFR 1910.107(b)(3), 29 CFR 1910.120(j)(1), 29 CFR 1910.1450(e), 49 CFR 173.12 (b)(2)(iv). See page 123 for details.

TRANSFORMER™ Gray Universal Pads				
Item #	Description	Size	Units/Pkg	Absorbs/Pkg
GRSMF100H-BX	HeavyWeight Roll in Dispenser Box	15" x 100'	1	18.9 gal.

DrumTop Pads

Say goodbye to messy drum tops.

- Absorb drips from leaking pumps to help keep drum storage areas looking good
- Precut bung holes make for easy access to drum
- Pads can be removed and replaced with pumps and valves installed
- Grunge-hiding gray signifies universal sorbency for oils, coolants, solvents and water
- Made from top-quality COMMANDER Mat

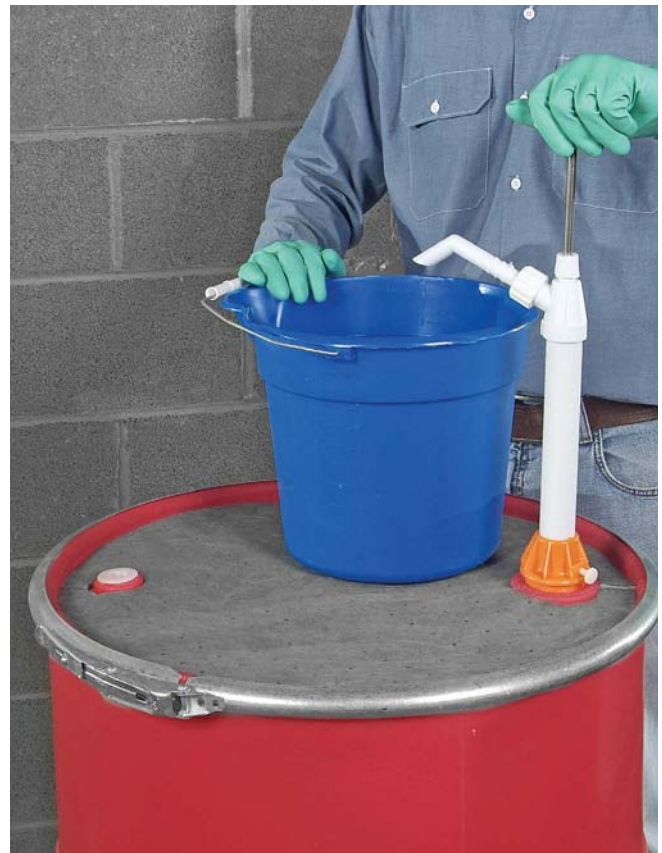

DrumTop Pads

Item #	Description	Size	Units/Pkg	Absorbs/Pkg
GTOP	HeavyWeight Pads	22" dia.	25	8.6 gal.



COMMANDER Mini Roll

Soak up drips, spills and splatters.

- Easier to use than floor sweep so it reduces cleanup time; just put it down, let it work and pick it back up
- Free of damaging grit and dust, so it's perfect for use around delicate sensors, parts and tools
- Compact, grab-and-go roll size is great for mobile techs

Universal COMMANDER™ Mini Roll

Item #	Description	Size	Units/Pkg	Absorbs/Pkg
GRSF1550S	LightWeight Rolls	15" x 50'	12	53.4 gal.

Magnetic Roll Holder

Item #	Description	Size	Units/Pkg
A-MAGRACK	Roll Holder Dispenser with Magnets	5.5" x 17" x 2"	1



Magnetic Roll Holder (A-MAGRACK) attaches to any metal surface to keep mat off the floor and close at hand. Ideal for attaching to tool boxes, car lifts, support beams or other metal surfaces.

A-MAGRACK



GRSF1550S



Universal Socks

Solid performers in a variety of situations.

- Use them wherever you have a variety of spills and only want to stock one sock to cover everything.
- Very flexible to conform around machine bases and offers a snug fit with no seepage
- Easy and convenient to put into place



GSO815

Cellulose Socks

Item #	Description	Size	Units/Pkg	Absorbs/Pkg
GS0410	Universal Socks	3" x 4'	10	8.3 gal.
GS0430	Universal Socks	3" x 4'	30	25.0 gal.
GS0815	Universal Socks	3" x 8'	15	25.0 gal.
GS01210	Universal Socks	3" x 12'	10	25.0 gal.

CornCob Socks

An affordable alternative to messy clay.

- Economical and highly efficient for even the toughest jobs
- Absorb ½ gallon of oil, coolants, solvents and water — nearly twice as much as clay, but without the dust or the mess to clean up afterward; incinerable
- Ideal for surrounding spilled fluids or wrapping around leaky machines
- USDA BioPreferred approved



CornCob Socks

Item #	Description	Size	Units/Pkg	Absorbs/Pkg
CCS040	CornCob Socks	3" x 42"	40	20.0 gal.



Universal Sock/Net Boom

Fast, efficient response for large spills.

- Just one of these high-capacity booms can contain and soak up 5.8 gallons of oils, coolants, solvents or water
- Booms won't shed, even when saturated
- A nylon rope and sturdy hardware ensure long-lasting durability and easy retrieval
- Use boom connectors to create a containment system big enough to handle almost any size spill



Universal Sock/Net Boom

Item #	Description	Size	Units/Pkg	Absorbs/Pkg
GB510SN	Universal Booms	5" x 10'	4	23.3 gal.

Universal Pillows

Absorb high-volume leaks and spills of oils, coolants, solvents or water.

- Easy to place in hard-to-reach areas — use under machines and leaky hydraulic hoses or wedge in corners cramped for space
- Pulls liquids from the floor like a sock, catches leaks like a pan, and absorbs spills like a pad
- Large surface area speeds the absorption process and shortens overall response time



Universal Pillows

Item #	Description	Size	Units/Pkg	Absorbs/Pkg
GPIL1818	Universal Pillows	18" x 18"	10	23.0 gal.
GPIL818	Universal Pillows	8" x 18"	20	23.0 gal.
GPIL1010	Universal Pillow	10" x 10"	40	30.0 gal.

Universal Pans

Economical solution to high-volume leaks and drips.

- Easy to place in hard-to-reach areas — use under machines and leaky hydraulic hoses
- **GPIL1224** Universal Pillow absorbs up to 3 quarts of oils, coolants, solvents or water
- **DPU-16** High-capacity, low-profile Universal DripPan is perfect for heavy leak areas and tight spaces

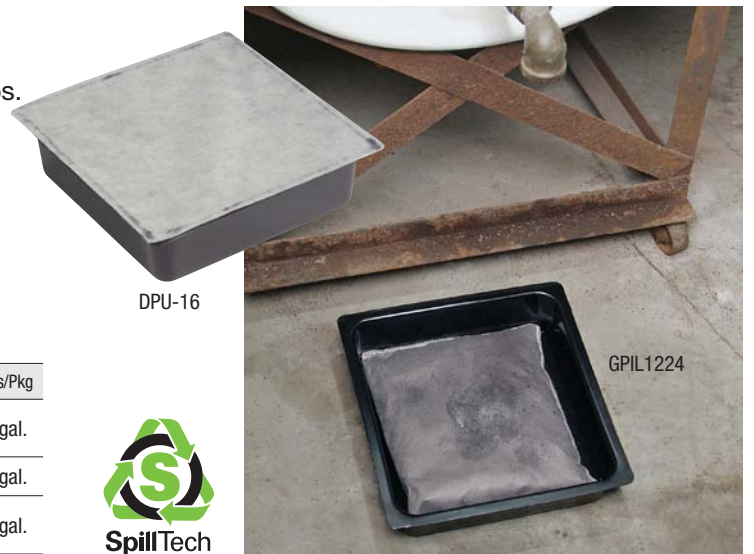

Universal Pans

Item #	Description	Size	Units/Pkg	Absorbs/Pkg
GPIL1224	Universal Pillow in a Pan	10.5"sq. x 3"H	12 pans & 24 pillows	18.0 gal.
GPIL1010	Universal Pillow Refill	10" x 10"	40	30.0 gal.
DPU-16	Universal DripPans	10.5"sq. x 3"H	16	16.0 gal.

Oil-Dri Loose Sorbent

Absorb leaks, drips and spills with a premium dry absorbent.

- Clay granules absorb liquids around machines or in storage areas
- Superior moisture extraction process increases clay's absorption power and minimizes dust



Oil-Dri™

Item #	Description	Size	Qty/Pallet	Absorbs/Pkg
NEW CLAY32	Oil-Dri™ Loose Sorbent	35-lb. Bag	69	3.75 gal.

Gran-sorb Loose Sorbent

Loose Cellulose Absorbent soaks up oils, coolants, solvents, water, fuels and antifreeze.

- Paper waste is completely safe, non-toxic and non-hazardous
- Absorbs its own weight in liquid
- Great alternative to clay

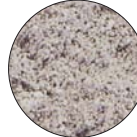

Gran-sorb® Loose Sorbent

Item #	Description	Size	Qty/Pallet	Absorbs/Pkg
CELL30	Gran-sorb® Loose Sorbent	30-lb. Bag	65	4.0 gal.

Loose CornCob

Great all-purpose sorbent soaks up a variety of fluids.

- Takes in oils, coolants, solvents and water
- Made from all-natural coarse corncob
- Much lighter than clay



Loose CornCob

Item #	Description	Size	Qty/Pallet	Absorbs/Pkg
COB40	Loose CornCob	40-lb. Bag	50	8.5 gal.

Lite-Zorb Loose Sorbent

Recycled paper waste absorbs five times as much as clay, without the dust.

- Fast wicking, non-abrasive and non-toxic
- Great for efficient, fast leak and spill response

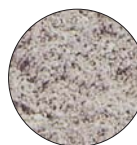

Lite-Zorb Loose Sorbent

Item #	Description	Size	Qty/Pallet	Absorbs/Pkg
MR1020	Lite-Zorb Loose Sorbent	25-lb. Bag	80	5.4 gal.

SuperSorb Loose Sorbent

Instantly soak up liquids to leave surfaces totally dry.

- Concentrated formula absorbs 10 to 12 times more than clay



SuperSorb Loose Sorbent

Item #	Description	Size	Qty/Pallet	Absorbs/Pkg
SS1	SuperSorb Loose Sorbent	28-oz. Shakers	720	0.6 gal.
SS12	SuperSorb Loose Sorbent	(12) 28-oz. Shakers	60	7.0 gal.
SS5	SuperSorbent Loose Sorbent	5-gal. Pail	60	6.0 gal.

Fluidloc Sorbent

Solidify bodily fluids for safer, easier cleanup.

- Sorbent for biohazards like blood, vomit and urine
- FL12 absorbs a whopping 780 gal./package



Fluidloc™ Sorbent (absorbs water-based liquids)

Item #	Description	Size	Qty/Pallet	Absorbs/Pkg
FL1	Fluidloc™ Sorbent	48-oz. Shaker	1,584	13.5 gal.
FL12	Fluidloc™ Sorbent	48-oz. Shakers	132	162 gal.

CONTRACTOR GRADE

The economical solution for fast cleanup of oil spills.

OIL-ONLY ABSORBENCY: For oils, not water

APPLICATION: General applications, economical

DURABILITY: ● ● ● ● ●

ABSORBENCY: ● ● ● ● ●

AVAILABLE IN: 

CONTRACTOR GRADE

MAT CONSTRUCTION

Single layer of meltblown polypropylene, dimpled for wicking power

Meltblown

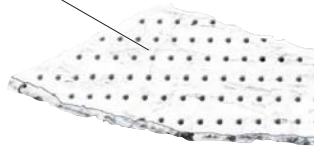

FEATURES AND BENEFITS

- Absorbent meltblown polypropylene mat repels water and soaks up only oil and oil-based fluids
- Perfect for light-duty industrial and maintenance applications
- Absorbs leaks, spills and overspray
- Rolls are great for covering large surface areas
- Pads are great for general cleanup applications
- Pads perforated at 7.5" up the center; use only what you need and save money
- Rolls perforated every 7.5" vertically and cross-perforated at 17" horizontally; take only the size you need for your application

HYC

Helps you comply with 29 CFR 1910.22(a)(2), 29 CFR 1910.107(b)(3), 29 CFR 1910.107(g)(2), 29 CFR 1910.120(j)(1), 29 CFR 1910.1450(e), and 49 CFR 173.12 (b)(2)(iv). See page 123 for details.

- Economical
- Good for General Applications
- Designed for Short-Term Use

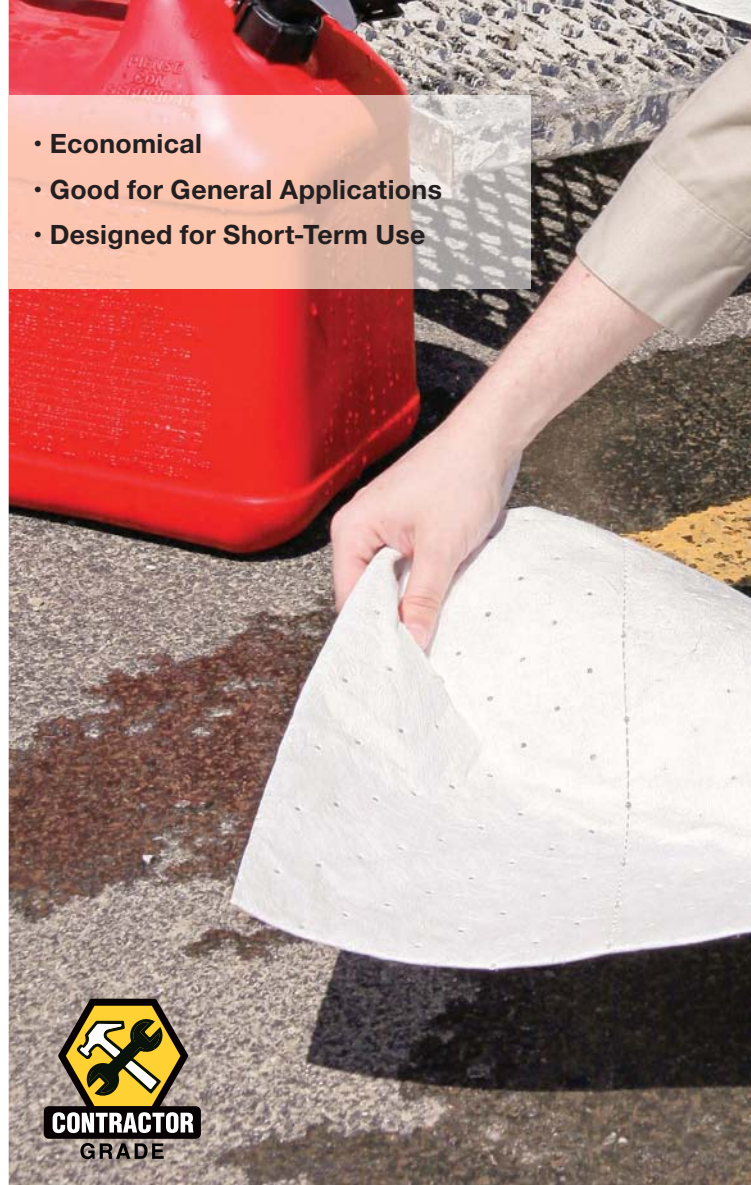



Economy You Can Count On.

If your priority is economy and short-term use for oil spills, Contractor Grade absorbents are a good choice. These oil-only pads, rolls and booms are versatile enough for most outdoor uses.



Smart Selection Tip:

Look for the Contractor Grade Symbol and save.

If budget is your top priority, we've made it easy for you to spot our economical line of absorbents. Look for the Contractor Grade symbol at right! See our Contractor Grade Universal Pads and Rolls on pages 6-7.



Contractor Grade mats are perforated, unlike other entry-level mats. Rip off only what you need to waste less and save money.

CONTRACTOR GRADE White Oil-Only Pads

Item #	Description	Size	Units/Pkg	Absorbs/Pkg
WP-H	HeavyWeight Pads	15" X 18"	100	22 gal.
WP-M	MediumWeight Pads	15" X 18"	100	20 gal.
WP-S	LightWeight Pads	15" X 18"	200	35 gal.

CONTRACTOR GRADE White Oil-Only Rolls

Item #	Description	Size	Units/Pkg	Absorbs/Pkg
WR-H	HeavyWeight Roll	30" X 150'	1	44 gal.
WR-M	MediumWeight Roll	30" X 150'	1	40 gal.



WP-H



WP-S



WR-M



WR-H



- Highly Absorbent
- Quick Oil-Only Cleanup
- Effective for Marine Spills

RESPONDER

Economical meltblown mat for effective oil spill response.

OIL-ONLY ABSORBENCY: For oils, not water

APPLICATION: Marine Spills, Economical

DURABILITY: ● ● ● ○ ○

ABSORBENCY: ● ● ● ● ●

AVAILABLE IN: 

FEATURES AND BENEFITS

- Best performing pad on water due to fast-wicking fibers
- Highly absorbent meltblown polypropylene mat repels water and soaks up only oil and oil-based fluids
- Floats even when completely saturated — most effective for marine spills
- Not perforated so saturated mat stays intact for easy retrieval

**NEED A BOOM FOR YOUR OIL ON WATER RESPONSE?
See SpillTech Booms - Page 38-39**

RESPONDER

MAT CONSTRUCTION

Single layer of hydrophobic (oil-only) polypropylene.

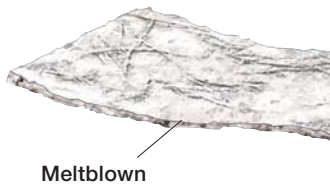

Ideal for outdoor use — Responder Mat provides quick, efficient cleanup to help protect the environment from contamination.

HYC

Helps you comply with 29 CFR 1910.22(a)(2), 29 CFR 1910.120(j)(1), 29 CFR 1910.1450(e), 40 CFR 263.30(a), 40 CFR 263.31, 49 CFR 173.12 (b)(2)(iv). See page 123 for details.



Smart Selection Tip:

Perf-free for better performance on water!

Choosing a mat with perforations can be advantageous for some applications. If you'd like flexibility in choosing your mat size, for example, perforations allow you to take what you need and save money.

For water applications, however, perforations can be a disadvantage. Whether it's on a stream, retention pond or open water, deploying mats to soak up an oily spill on water is just the first step. You also need to retrieve them once they're saturated and heavy.

SpillTech's Responder Mats are not scored or perfed, so after doing their job, they hold together while being hauled back ashore for easier, quicker cleanup.



RESPONDER™ White Oil-Only Pads

Item #	Description	Size	Units/Pkg	Absorbs/Pkg
WP100H	HeavyWeight Pads	15" x 19"	100	33.4 gal.
WPK50H	HeavyWeight King Pads	30" x 30"	50	52.8 gal.
WP100M	MediumWeight Pads	15" x 19"	100	26.7 gal.
WP200S	LightWeight Pads	15" x 19"	200	35.7 gal.
WP100S	LightWeight Pads	15" x 19"	100	17.9 gal.

RESPONDER™ White Oil-Only Rolls

Item #	Description	Size	Units/Pkg	Absorbs/Pkg
WR150H	HeavyWeight Roll	30" x 150'	1	63.4 gal.
WRS150H	HeavyWeight Split Rolls	15" x 150'	2	63.4 gal.
WR150M	MediumWeight Roll	30" x 150'	1	50.7 gal.
WR300S	LightWeight Roll	30" x 300'	1	67.9 gal.



WP100H



WPK50H



WRS150H



WR150M



DEFENDER

Highly absorbent SonicBonded mat for oily spills and overspray.

OIL-ONLY ABSORBENCY: For oils, not water

APPLICATION: Overspray and Spills, General Use

DURABILITY: ● ● ● ○ ○

ABSORBENCY: ● ● ● ● ○

AVAILABLE IN:

DEFENDER

MAT CONSTRUCTION

One layer of spunbond fabric is ultrasonically bonded to a single layer of meltblown sorbent.

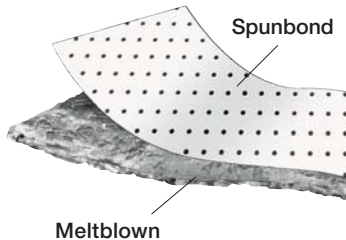

FEATURES AND BENEFITS

- Abrasion-resistant top layer gives pads and rolls strength for everyday cleanup jobs
- Perfect for medium-duty industrial, maintenance and general applications
- Quickly absorbs leaks, spills and overspray to keep floors dry
- Pads perforated at 7.5" up the center; King pads are perfed up center 15"
- Rolls perforated every 7.5" vertically and cross-perforated at 17" horizontally
- Oil selective — repels water but absorbs oil and all oil-based fluids



- Everyday Use
- Absorbs on Contact
- Perforated for Your Needs



HYC

Helps you comply with 29 CFR 1910.22(a)(2), 29 CFR 1910.107(b)(3), 29 CFR 1910.107(g)(2), 29 CFR 1910.120(j)(1), 29 CFR 1910.1450(e), and 49 CFR 173.12 (b)(2)(iv). See page 123 for details.

The Perfect Starter Mat!

Not sure what type of mat you need? Start here! Defender Mat hits that sweet spot where absorbency meets durability for all-around solid performance. Bonus: Spunbond side is lower linting for wiping purposes.



Oil-Only Defender Mat is suitable for outdoor use, absorbing oil but not water in marine applications.



Defender Mat is efficient and reliable for indoor applications, soaking up all of your machine leaks and overspray.

DEFENDER™ White Oil-Only Pads

Item #	Description	Size	Units/Pkg	Absorbs/Pkg
WPB100H	HeavyWeight Pads	15" x 19"	100	29.1 gal.
WPB50H	HeavyWeight Pads	15" x 19"	50	14.6 gal.
WPKB50H	HeavyWeight King Pads	30" x 30"	50	45.3 gal.
WPB100M	MediumWeight Pads	15" x 19"	100	24.7 gal.
WPB50M	MediumWeight Pads	15" x 19"	50	12.4 gal.
WPB200S	LightWeight Pads	15" x 19"	200	31.1 gal.
WPB100S	LightWeight Pads	15" x 19"	100	15.6 gal.



WPB100H



WPKB50H

DEFENDER™ White Oil-Only Rolls

Item #	Description	Size	Units/Pkg	Absorbs/Pkg
WRB150H	HeavyWeight Roll	30" x 150'	1	55.2 gal.
WRSB150H	HeavyWeight Split Rolls	15" x 150'	2	55.2 gal.
WRB150M	MediumWeight Roll	30" x 150'	1	46.1 gal.
WRSB150M	MediumWeight Split Rolls	15" x 150'	2	46.1 gal.
WRB300S	LightWeight Roll	30" x 300'	1	59.1 gal.



WRSB150H



WRB150M



- Most Popular
- Good for Foot Traffic
- Strong Enough for Heavy Spills

COMMANDER

Durable Fine Fiber mat controls oil under machines and conveyors.

OIL-ONLY ABSORBENCY: For oils, not water

APPLICATION: Under Machines and Conveyors, Walkways

DURABILITY: ●●●●○

ABSORBENCY: ●●●●○

AVAILABLE IN: 

FEATURES AND BENEFITS

- Most popular mat used in industrial cleanup applications
- Use near machinery, in production areas and under assembly lines and conveyors
- 3-ply construction is strong and absorbent to take command of leaks and spills
- Perforations allow you to tear pads and rolls into different sizes based on your application
- Two hi-viz color options — blue is great in snowy areas where pad placement needs to be traced
- Oil selective — repels water but absorbs oil and all oil-based fluids
- Pads perforated at 7.5" up the center
- Rolls perforated every 7.5" vertically and cross-perforated at 17" horizontally

COMMANDER

MAT CONSTRUCTION

Two layers of Fine Fiber polypropylene are ultrasonically bonded around a high-loft meltblown core.

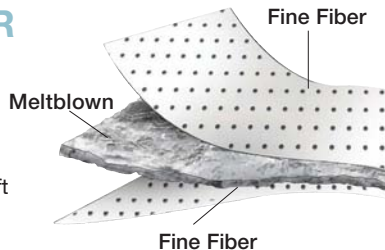

HYC

Helps you comply with 29 CFR 1910.22(a)(2), 29 CFR 1910.107(b)(3), 29 CFR 1910.107(g)(2), 29 CFR 1910.120(j)(1), 29 CFR 1910.1450(e) and 49 CFR 173.12 (b)(2)(iv). See page 123 for details.



CHOOSE BLUE FOR SNOW!

- Hi-viz blue is great in snowy areas where pad placement needs to be traced
- Oil selective — repels water but absorbs oil and all oil-based fluids

COMMANDER™ Blue Oil-Only Pads

Item #	Description	Size	Units/Pkg	Absorbs/Pkg
BPF100H	HeavyWeight Pads	15" x 19"	100	26.3 gal.
BPF100H-BX	HeavyWeight Pads in Dispenser Box	15" x 19"	100	26.3 gal.
BPF200S	LightWeight Pads	15" x 19"	200	28.1 gal.

COMMANDER™ Blue Oil-Only Roll

Item #	Description	Size	Units/Pkg	Absorbs/Pkg
BRF150H	HeavyWeight Roll	30" x 150'	1	49.8 gal.

COMMANDER™ White Oil-Only Pads

Item #	Description	Size	Units/Pkg	Absorbs/Pkg
WPF100H	HeavyWeight Pads	15" x 19"	100	26.3 gal.
WPF1014H	HeavyWeight Pads	10" x 14"	100	18.1 gal.
WPF100H-BX	HeavyWeight Pads in Dispenser Box	15" x 19"	100	26.3 gal.
WPKF50H	HeavyWeight King Pads	30" x 30"	50	41.6 gal.
WPF100M	MediumWeight Pads	15" x 19"	100	20.8 gal.
WPF200S	LightWeight Pads	15" x 19"	200	28.1 gal.

COMMANDER™ White Oil-Only Rolls

Item #	Description	Size	Units/Pkg	Absorbs/Pkg
WRF150H	HeavyWeight Roll	30" x 150'	1	49.8 gal.
WRF100H-BX	HeavyWeight Roll in Dispenser Box	15" x 100'	1	19.3 gal.
WRSF150H	HeavyWeight Split Rolls	15" x 150'	2	49.8 gal.
WRF150M	MediumWeight Roll	30" x 150'	1	39.5 gal.



WPF100H-BX



BRF150H



WRSF150H



WRF100H-BX



- Durable for Rugged Applications
- Great for Cleaning Oily Tools and Parts
- Low-Lint

PROTECTOR

Tough multilaminate mat stands up to punishing, oily applications.

OIL-ONLY ABSORBENCY: For oils, not water

APPLICATION: Oily Tools and Parts, Demanding Environments

DURABILITY: ● ● ● ● ●

ABSORBENCY: ● ● ● ● ○

AVAILABLE IN:

FEATURES AND BENEFITS

- Abrasion-resistant outer layers of spunbond material are strong with low-lint benefits
- Mat is a great choice for lining tool benches, wiping down machinery or cleaning oily tools and parts
- Perfect for industrial applications in demanding environments where durability is most important
- In outdoor applications, the mat won't tear when pulled up from frozen ground
- Pads perforated at 7.5" up the center
- Rolls perforated every 7.5" vertically and cross-perforated at 17" horizontally

PROTECTOR

MAT CONSTRUCTION

High-loft meltblown sorbent is ultrasonically bonded between two layers of lint-free spunbond fabric.

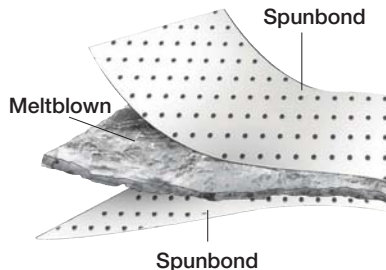

WANT SMOOTH, EASY ROLL DISPENSING?
See our RollRacks - Page 49

HYC

Helps you comply with 29 CFR 1910.22(a)(2), 29 CFR 1910.120(j)(1), 29 CFR 1910.1450(e) and 49 CFR 173.12 (b)(2)(iv). See page 123 for details.



CHOOSE BLUE FOR SNOW!

- Hi-viz blue is great in snowy areas where pad placement needs to be traced
- In outdoor applications, the mat won't tear when pulled up from frozen ground

PROTECTOR™ Blue Oil-Only Pads

Item #	Description	Size	Units/Pkg	Absorbs/Pkg
BPL100H	HeavyWeight Pads	15" x 19"	100	28.9 gal.

HYC

Helps you comply with 29 CFR 1910.22(a)(2), 29 CFR 1910.120(j)(1), 29 CFR 1910.1450(e) and 49 CFR 173.12 (b)(2)(iv). See page 123 for details.

PROTECTOR™ White Oil-Only Pads

Item #	Description	Size	Units/Pkg	Absorbs/Pkg
WPL100H	HeavyWeight Pads	15" x 19"	100	28.9 gal.
WPL100M	MediumWeight Pads	15" x 19"	100	23.4 gal.



WPL100H

PROTECTOR™ White Oil-Only Rolls

Item #	Description	Size	Units/Pkg	Absorbs/Pkg
WRL150H	HeavyWeight Roll	30" x 150'	1	54.9 gal.
WRSL150H	HeavyWeight Split Rolls	15" x 150'	2	54.9 gal.
WRL150M	MediumWeight Roll	30" x 150'	1	44.4 gal.
WRSL150M	MediumWeight Split Rolls	15" x 150'	2	44.4 gal.



WRL150H



WRSL150M



ARRESTOR

Specially treated to dissipate static and safely absorb volatile fuels and other petroleum-based liquids.

- Use where static electricity is a problem or where vapors can ignite
- A safer alternative for cold applications, low humidity climates or dry environments
- Mat has many applications in aviation industry where jet fuel is present and the utility industry for electrical work
- Single-layer polypropylene absorbs fast for quick response
- Oil selective — repels water but absorbs oil and all oil-based fluids
- Packaged in blue static-dissipative bag for quick identification

ARRESTOR™ White Oil-Only Static-Dissipative Pads

Item #	Description	Size	Units/Pkg	Absorbs/Pkg
WPX50H	HeavyWeight Pads	15" x 19"	50	16.8 gal.
WPX100H	HeavyWeight Pads	15" x 19"	100	33.6 gal.

ARRESTOR™ White Oil-Only Static-Dissipative Rolls

Item #	Description	Size	Units/Pkg	Absorbs/Pkg
WRX150H	HeavyWeight Roll	30" x 150'	1	63.4 gal.



WPX50H



WRX150H

HYC Helps you comply with 29 CFR 1910.22(a)(2), 29 CFR 1910.1450(e), 29 CFR 1910.120(j)(1) and 49 CFR 173.12 (b)(2) (iv). See page 123 for details.



TRANSFORMER

Versatile mat that's a roll, a pad and a sock in one

- Perfed 3.75" vertically and 17" horizontally to tailor mat's dimensions to your applications
- 3-ply construction designed for walkways — tough SpunBond top, highly absorbent core and FineFiber bottom
- Packaged in a convenient dispenser box

Smart Selection Tip:

TAKE ADVANTAGE OF SMART PERFS!

Rip or fold along the perforations to customize your mat.

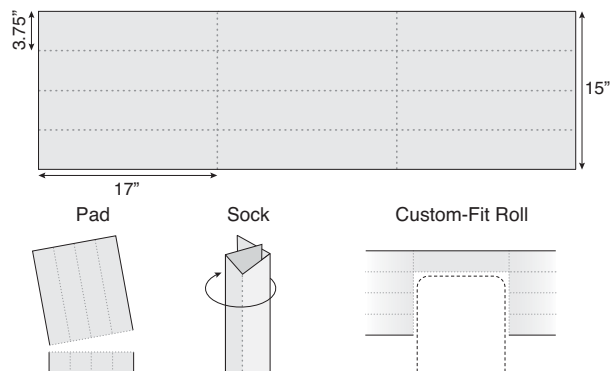

TRANSFORMER™ White Oil-Only Pads

Item #	Description	Size	Units/Pkg	Absorbs/Pkg
WRSMF100H-BX	HeavyWeight Roll in Dispenser Box	15" x 100'	1	18.9 gal.



WRSMF100H-BX

HYC Helps you comply with 29 CFR 1910.22(a)(2), 29 CFR 1910.1450(e), 29 CFR 1910.107(g)(2), 29 CFR 1910.107(b)(3), 49 CFR 173.12 (b)(2)(iv) and 29 CFR 1910.120(j)(1). See page 123 for details.



DrumTop Pads

Eliminate messy drum tops with these Sorbent Oil-Only DrumTop Pads.

- Absorb drips from leaking pumps and help keep drum storage areas looking clean
- Precut bung holes make for easy access to drum



BTOP

DrumTop Pads

Item #	Description	Size	Units/Pkg	Absorbs/Pkg
BTOP	Oil-Only DrumTop Pads	23" Dia.	25	8.6 gal.



RIG160H

Rig Mats

Save your sites costly cleanups by stopping the mess before it starts.

- Ideal for service rigs, sucker rod maintenance, wellhead maintenance, cleaner drilling and clean compressor houses
- Perfect for outdoor use — mat provides quick, efficient cleanup to help protect the environment from contamination



RIG160H

Rig Mat Rolls

Item #	Description	Size	Units/Pkg	Absorbs/Pkg
RIG160H	HeavyWeight Roll	58" x 160'	1	122.3 gal.

HYC

Helps you comply with 29 CFR 1910.22(a)(2), 29 CFR 1910.1450(e), 29 CFR 1910.107(g)(2), 29 CFR 1910.107(b)(3) and 29 CFR 1910.120(j)(1). See page 123 for details.



Oil-Only Socks

Oil-only socks absorb oils, repel water.

- Soak up petroleum-based fluids quickly while repelling water
- Socks float for cleanup of waterborne hydrocarbons
- Flexible to conform around machine bases and offer a snug fit with no seepage
- Contain spills to keep fluids from spreading into larger areas and becoming slippery hazards
- White designates oil-only sorbency and makes it easy to identify when saturated



WSO410

Oil-Only Socks

Item #	Description	Size	Units/Pkg	Absorbs/Pkg
WSO410	Oil-Only Socks	3" x 4'	10	8.33 gal.
WSO430	Oil-Only Socks	3" x 4'	30	25.0 gal.
WSO815	Oil-Only Socks	3" x 8'	15	25.0 gal.
WSO1210	Oil-Only Socks	3" x 12'	10	25.0 gal.

HYC

Helps you comply with 29 CFR 1910.120(j)(1), 40 CFR 112.7(c)(1), 40 CFR 263.30(a), and 40 CFR 263.31. See page 123 for details.

Oil-Only Pillows

Oil-only pillows are easy to place in hard-to-reach areas.

- Absorb high-volume leaks and spills of oil and other petroleum-based liquids on land or water
- Use under machines and leaky hydraulic hoses or wedge in corners cramped for space
- Pulls liquids from the floor like a sock, catches leaks like a pan, and absorbs spills like a pad
- Large surface area speeds the absorption process and shortens the overall response time on land or water



WPIL818

WPIL1818

Oil-Only Pillows

Item #	Description	Size	Units/Pkg	Absorbs/Pkg
WPIL1818	Oil-Only Pillows	18" x 18"	10	23.0 gal.
WPIL818	Oil-Only Pillows	8" x 18"	20	23.0 gal.
WPIL1010	Oil-Only Pillows	10" x 10"	40	30.0 gal.

HYC

Helps you comply with 29 CFR 1910.120(j)(1), 33 CFR 154.1047(c)(2), 40 CFR 112.7(c)(1), 40 CFR 263.30(a), 40 CFR 263.31 and 49 CFR 173.12 (b)(2)(iv). See page 123 for details.

Oil-Only Pans

An economical solution to high-volume leaks and drips.

- Each Oil-Only Pillow in a Pan absorbs and contains up to 3 quarts of oil or other oil-based liquid while actually repelling water
- Ideal choice for catching recurring or continuous high-volume leaks
- No preparation required — simply set it in place, and watch it go to work
- Use the high-capacity, low-profile Oil-Only Drip Pan under machines and leaky hydraulic hoses, or place one under any leak or drip that produces a high volume in a short time



WPIL1224

DPO-16

Pillow in a Pan & DripPans

Item #	Description	Size	Units/Pkg	Absorbs/Pkg
WPIL1224	Oil-Only Pillow in a Pan	10.5" sq. x 3"H	12 pans & 24 pillows	18.0 gal.
WPIL1010	Oil-Only Pillows Refill	10" x 10"	40	30.0 gal.
DPO-16	Oil-Only DripPan	10.5" sq. x 3"H	16	12.0 gal.

HYC

Helps you comply with 29 CFR 1910.22(a)(2) and 49 CFR 173.12 (b)(2)(iv). See page 123 for details.



- UV Resistant
- Great for Long-Term Deployment
- Best Choice for Oil on Water

PREMIUM BOOMS

Highest quality you can buy for long-term use on water.



- Durable construction makes it ideal for continuous, long-term deployment — stays on the job up to 12 months!



- UV-treated sleeve withstands 12 months of direct sunlight for successful long-term use.



- Polypropylene construction is guaranteed not to take on water. Save all of your absorbency for oil!

FEATURES AND BENEFITS

- 100% polypropylene boom repels water so you use all of your absorbency on oil, guaranteed
- UV-treated sleeve withstands 12 months of direct sunlight
- Ideal for long-term deployment on open water; also good for immediate spill response
- Integrated connectors link booms together to create a containment system big enough to handle almost any spill size

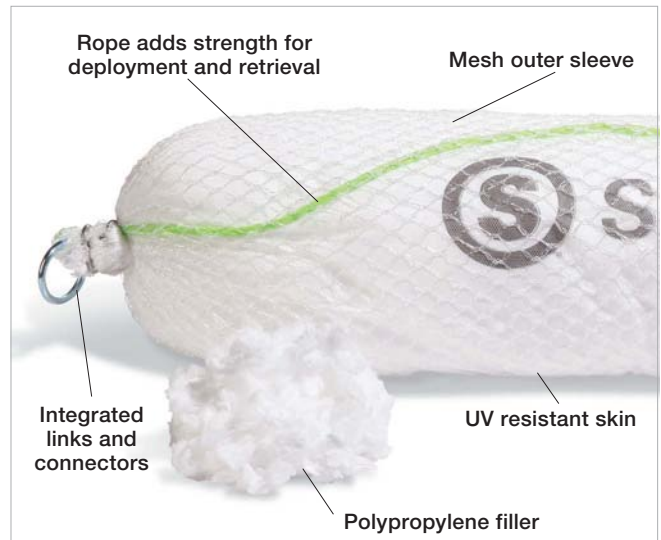

HYC Helps you comply with 33 CFR 154.1047(c)(2), 40 CFR 112.7(c)(1), 40 CFR 122.26 and 40 CFR 263.31. See page 123 for details.



Withstands up to 12 months of direct sunlight – UV-treated.



Great for long-term deployment; won't take on water!



Link booms to cover large areas.

PREMIUM Oil-Only Booms

Item #	Description	Size	Absorbs/Pkg	Qty/Pkg
PREM510	Premium Boom	5" X 10'	30 gal.	4
PREM810	Premium Boom	8" X 10'	38 gal.	4



CONTRACTOR GRADE BOOMS

Smart choice for economical, short-term use.

FEATURES AND BENEFITS

- Poly-blend filler repels water while absorbing oil and other hydrocarbons
- Connectors link booms together to create a containment system big enough to handle almost any spill size
- Provides quick, efficient cleanup to help protect the environment from contaminants; suited for short-term use

CONTRACTOR GRADE Oil-Only Booms

Item #	Description	Size	Absorbs/Pkg	Qty/Pkg
WB410SN	Sock/Net Booms	4" X 10'	19.5 gal.	4
WB510SN	Sock/Net Booms	5" X 10'	30 gal.	4
WB520SN	Sock/Net Booms	5" X 20'	30 gal.	2
WB810SN	Sock/Net Booms	8" X 10'	38 gal.	4
WB820SN	Sock/Net Booms	8" X 20'	38 gal.	2



HYC

Helps you comply with 29 CFR 1910.22(a)(2), 29 CFR 1910.120(j)(1), 29 CFR 1910.1450(e), 40 CFR 263.30(a), 40 CFR 263.31, 40CFR 122.26 and 33 CFR154.1047 (c)(2). See page 123 for details.



PomPoms

- Heavy oils adhere but water is repelled so PomPoms won't become weighed down, allowing you to leave them in place longer for maximum effectiveness
- PomPoms float on the water's surface to absorb oily spills and even surface sheen

PomPoms

Item #	Description	Absorbs/Pkg	Qty/Pkg
APMPM	PomPoms/30 individual	11.6 gal.	30
APMPM-R	PomPoms/30 on 50' rope	11.6 gal.	1



WBB818

WBB318

Bilge Booms

- Removes oils without emptying your bilges and sumps, no matter how deep they are
- Booms won't shed or sink, even when saturated with oil

Oil-Only Bilge Booms

Item #	Description	Size	Units/Pkg	Absorbs/Pkg
WBB318	Bilge Booms	3" x 18"	20	6.25 gal.
WBB818	Bilge Booms	8" x 18"	10	18.0 gal.



Folded Sweep

- Attach a Folded Sweep to your sorbent boom for maximum on-the-water cleanup
- Floats on water to absorb oily spills and even surface sheen
- Sturdy webbing and hardware for easy deployment and retrieval

PROTECTOR™ Folded Sweep

Item #	Description	Size	Absorbs/Pkg	Qty/Pkg
WSWL100F	Folded Sweep	19"W x 100'L	25.3 gal.	1

Net Bags

- Loose poly-blend filler encased in a nylon mesh bag
- Net Bags absorb oily spills and even surface sheen on water
- Floats for easy retrieval — even when saturated



Net Bags

Item #	Description	Size	Absorbs/Pkg	Qty/Pkg
WPIL10	Net Bags	6" x 16" x 21"	37.0 gal.	10

Loose PeatMoss

- PEAT2 is made of biodegradable peat moss, which has a natural affinity for oils and will not absorb water; incinerable



Loose Sorbents

Item #	Description	Size	Absorbs/Pkg	Qty/Pallet
PEAT2*	Loose PeatMoss	2 cu. ft.	16.0 gal.	54

*Sold only in pallet quantities.

Containment Boom and Anchor System

Non-absorbent boom contains spills above and below water; anchor system keeps in place for optimum containment.

- Quickly contain spills and debris in water
- Boom floats to keep oil from spreading into or out of a contained area; skirt hangs below the surface to help prevent spills from creeping underneath
- Ballast chain adds weight to help keep skirt taut
- Ideal in water intakes, channels, API separators, ponds, lakes, streams, marinas, canals, ditches and other shallow areas



Comes pre-assembled for quick and easy deployment.

C-ANCHOR2

Containment Booms and Anchor System

Item #	Description	Size	Units/Pkg
C-BOOM10-50	Containment Boom	50'L x 10"H (4" float, 6" skirt)	1
C-BOOM10-100	Containment Boom	100'L x 10"H (4" float, 6" skirt)	1
C-BOOM18-50	Containment Boom	50'L x 18"H (6" float, 12" skirt)	1
C-BOOM18-100	Containment Boom	100'L x 18"H (6" float, 12" skirt)	1
† C-BOOM24-50	Containment Boom	50'L x 24"H (8" float, 16" skirt)	1
† C-BOOM24-100	Containment Boom	100'L x 24"H (8" float, 16" skirt)	1
C-ANCHOR2	Containment Boom Anchor System	22 lb. anchor system	1

*Final product may be yellow or orange based on availability at time of order.

† These Items drop ship from vendor

HYC

Helps you comply with 33 CFR 154.1047(c)(2), 40 CFR 112.7(c)(1). (Applies to C-BOOM only.) See page 123 for details

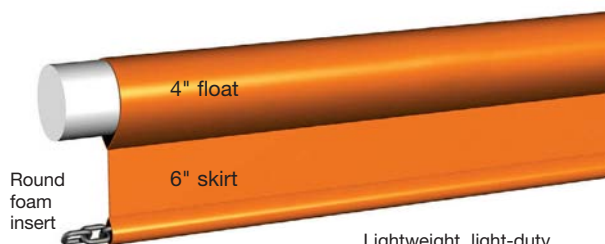

C-BOOM10

Lightweight, light-duty boom is ideal in shallow areas with minimal flow.

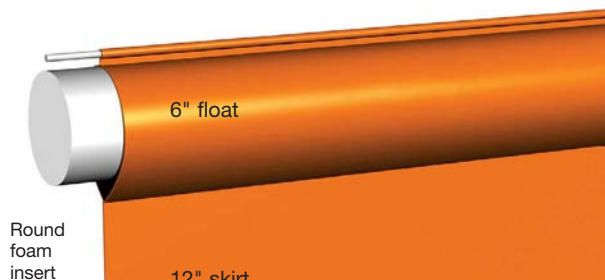

C-BOOM18

Versatile, medium-duty boom is ideal in areas with moderate to choppy flow.

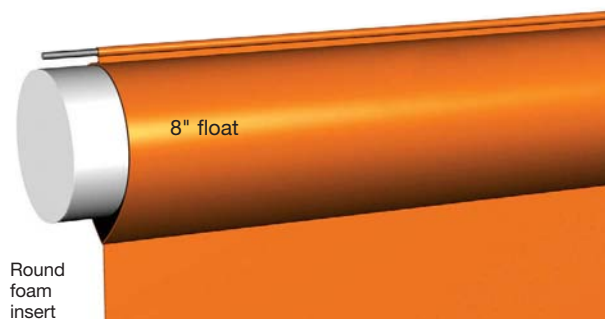

C-BOOM24

Rugged, heavy-duty boom is ideal in areas with fast, choppy flow.

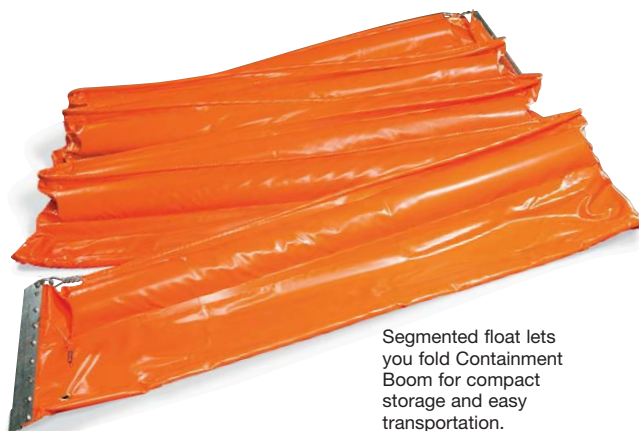

Segmented float lets you fold Containment Boom for compact storage and easy transportation.



- Absorbs Acids, Bases and Unknown Liquids
- Highly Absorbent
- Color-Coded for Quick Identification

DEFENDER

Economic choice for quick, efficient response to spills of hazardous or unknown liquids.

HAZMAT ABSORBENCY: Acids, bases & unknown liquids

APPLICATION: Hazardous and unknown liquids, labs and hospital spills

DURABILITY: ● ● ● ○ ○

ABSORBENCY: ● ● ● ● ○

AVAILABLE IN:

FEATURES AND BENEFITS

- Economical mat for aggressive chemical spills or unknown liquids
- 100% polypropylene mat is chemically compatible with most liquids
- Color-coded in cautionary yellow for quick identification
- Use for spill cleanup in university and research labs, hospitals, chemical or pharmaceutical plants and other facilities that use hazardous liquids
- Pads perforated at 7.5" up the center
- Rolls perforated every 7.5" vertically and cross-perforated at 17" horizontally

DEFENDER

MAT CONSTRUCTION

One layer of spunbond fabric is ultrasonically bonded to one layer of meltblown sorbent.

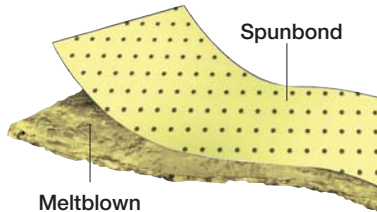

NEED A NEUTRALIZER?

See our range on - Page 47-48

HYC

Helps you comply with 29 CFR 1910.120(j)(1), 29 CFR 1910.1450(e), 40 CFR 263.31, and 49 CFR 173.12 (b)(2)(iv). See page 123 for details.



Smart Selection Tip:

PICK THE RIGHT STYLE SORBENT FOR YOUR TASK.

Some cleanup jobs need more than a mat. **HazMat Socks** fit snugly around the base of leaky drums and containers and are effective at surrounding spills to stop them from spreading. **HazMat Booms** include connectors that allow you to create a containment system big enough to handle any size spill. And **HazMat Pillows** have a large surface area and excellent absorbency for tackling big spills.

NEED A SOCK, BOOM OR PILLOW?

Find them on - Page 46



**HazMat
SOCKS**

**HazMat
BOOMS**

**HazMat
PILLOWS**

DEFENDER™ Yellow HazMat Pads

Item #	Description	Size	Units/Pkg	Absorbs/Pkg
YPB100H	HeavyWeight Pads	15" x 19"	100	29.1 gal.
YPB50H	HeavyWeight Pads	15" x 19"	50	14.6 gal.
YPB100M	MediumWeight Pads	15" x 19"	100	24.7 gal.
YPB50M	MediumWeight Pads	15" x 19"	50	12.4 gal.
YPB200S	LightWeight Pads	15" x 19"	200	31.1 gal.
YPB100S	LightWeight Pads	15" x 19"	100	15.5 gal.



YPB100H



YPB100M

DEFENDER™ Yellow HazMat Rolls

Item #	Description	Size	Units/Pkg	Absorbs/Pkg
YRB150H	HeavyWeight Roll	30" x 150'	1	55.2 gal.
YRSB150H	HeavyWeight Split Rolls	15" x 150'	2	55.2 gal.
YRB150M	MediumWeight Roll	30" x 150'	1	46.1 gal.



YRB150H



YRSB150H



- Absorbs Acids, Bases and Unknown Liquids
- High Durability and Low lint
- Color-Coded for Quick Identification

COMMANDER

Durable, quick and efficient response to spills of hazardous or unknown liquids.

HAZMAT ABSORBENCY: Acids, bases & unknown liquids

APPLICATION: Hazardous and unknown liquids, heavy foot traffic

DURABILITY: ● ● ● ● ○

ABSORBENCY: ● ● ● ● ○

AVAILABLE IN:

FEATURES AND BENEFITS

- 3-ply construction won't fall apart when responding to spill emergencies
- Used most often for aggressive liquid control in chemical or pharmaceutical plants
- Color-coded in cautionary yellow for quick identification
- 100% polypropylene mat is chemically compatible to most liquids
- Perforations allow you to tear pads and rolls into different sizes based on your application
- Pads perforated at 7.5" up the center (YPF1014H are unperfed)
- Rolls perforated every 7.5" vertically and cross-perforated at 17" horizontally

COMMANDER

MAT CONSTRUCTION

Two layers of fine fiber polypropylene are ultrasonically bonded around a high-loft meltblown core.

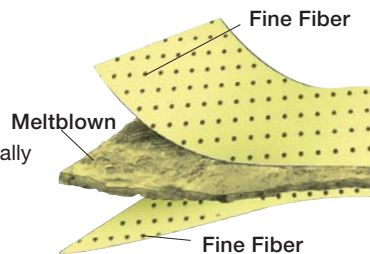

HYC

Helps you comply with 29 CFR 1910.120(j)(1), 29 CFR 1910.1450(e), 40 CFR 263.31, and 49 CFR 173.12 (b)(2)(iv). See page 123 for details.



Smart Selection Tip:



No matter what type of chemical you're working with, Commander Mat can handle it! Line work tables with Commander to catch routine splashes and drips and keep rolls on hand to respond to large spills.

**ALSO AVAILABLE:
HazMat Socks, Pillows
and Booms - See page 46**

COMMANDER™ Yellow HazMat Pads

Item #	Description	Size	Units/Pkg	Absorbs/Pkg
YPF100H	HeavyWeight Pads	15" x 19"	100	26.3 gal.
YPF1014H	HeavyWeight Pads	10" x 14"	100	18.1 gal.

COMMANDER™ Yellow HazMat Rolls

Item #	Description	Size	Units/Pkg	Absorbs/Pkg
YRF150H	HeavyWeight Roll	30" x 150'	1	49.8 gal.
YRSF150H	HeavyWeight Split Rolls	15" x 150'	2	49.8 gal.



YPF100H



YPF1014H



YRF150H



YRSF150H

HazMat Socks

Keep fluids from spreading to larger areas.

- 100% polypropylene filler for superior chemical compatibility
- Contain and absorb hazardous or unknown spills
- Fits snugly around the bases of leaky drums and containers
- Color-coded cautionary yellow for fast identification



YS0410

HazMat Poly Blend Socks

Item #	Description	Size	Units/Pkg	Absorbs/Pkg
YS0410	HazMat Socks	3" x 4'	10	8.33 gal.
YS0430	HazMat Socks	3" x 4'	30	25.0 gal.
YS0815	HazMat Socks	3" x 8'	15	25.0 gal.
YS01210	HazMat Socks	3" x 12'	10	25.0 gal.



HazMat Sock/Net Booms

Contain and absorb large-volume spills.

- Strong mesh outer sleeve encases a poly sock skin filled with a highly sorbent poly blend that won't shed
- Color-coded in hi-viz yellow for quick identification
- Durable, easy-to-use connectors link Sock/Net Booms together to create a containment system big enough to handle almost any size spill
- A nylon rope and sturdy hardware ensure durability and easy retrieval



HZ810SN

HZ510SN

HazMat Sock/Net Booms

Item #	Description	Size	Units/Pkg	Absorbs/Pkg
HZ510SN	HazMat Booms	5" x 10'	4	23.3 gal.
HZ810SN	HazMat Booms	8" x 10'	4	33.9 gal.



HazMat Pillows

Easy to deploy, quick to absorb.

- Able to hold over a gallon of liquid each
- Surface area and sizable amount of sorbent filler lets you attack large spills with speed and efficiency
- Pulls liquids from the floor like a sock, catches leaks like a pan and absorbs spills like a pad
- Color-coded in cautionary yellow for quick identification



YPIL1818

YPIL818

HazMat Poly Blend Pillows

Item #	Description	Size	Units/Pkg	Absorbs/Pkg
YPIL818	HazMat Pillows	8" x 18"	20	26.8 gal.
YPIL1818	HazMat Pillows	18" x 18"	10	29.1 gal.





ANS1

Visible color change signifies complete neutralization of acids.



Acid Neutralizing Sorbent

Changes color when absorbed acids have been neutralized and are safe to clean up.

- Visible color change signifies complete neutralization of acids
- Handy 32 oz. shaker makes it easy to transport and dispense sorbent
- Absorbs and solidifies liquids
- Environmentally friendly

NOTE: Not for use with hydrofluoric acid



ANS5

Acid Neutralizing Sorbent

Item #	Description	Size	Qty/Pkg	Absorbs/Pkg
ANS1	Acid Neutralizing Sorbent	32 oz. Shaker	1	.2 gal.
ANS12	Acid Neutralizing Sorbent	32 oz. Shaker	12	2.4 gal.
ANS5	Acid Neutralizing Sorbent	5-gal. Pail	1	2.5 gal.

HYC

Helps you comply with 29 CFR 1910.22(a)(2). See page 123 for details.

Battery Acid Neutralizer

Dissolve corrosion, dirt and grime from batteries.

- Neutralizes power-robbing corrosion and eliminates acid shorts and trickle discharges
- Effectively cleans battery posts, terminals, cables, casings, boxes, trays, fasteners and hold downs
- Easy to apply and safe to use on metal, plastic, rubber, and painted surfaces
- Biodegradable, non-corrosive, environmentally safe and contains no propellant
- Easy to use by applying on vertical surfaces and in hard-to-reach areas
- Changes color on contact with acid to detect corrosion of overcharged and/or leaking batteries

Battery Acid Neutralizer

Item #	Description	Size	Qty/Pkg
BAN1	Battery Acid Neutralizer	32 oz. Spray Bottle	1
BAN12	Battery Acid Neutralizer	32 oz. Spray Bottle	12





Base Neutralizer

Absorb and neutralize caustics and strong amines.

- Safely clean sodium hydroxide, potassium hydroxide and ammonium hydroxide as well as strong amines
- Neutralizer's pellet formula absorbs more and requires less clean-up than adsorbents; does not create "dust clouds"
- Non-hazardous, non-corrosive and biodegradable
- Safe, fast-acting and easy to use
- Reduces disposal costs and safety issues

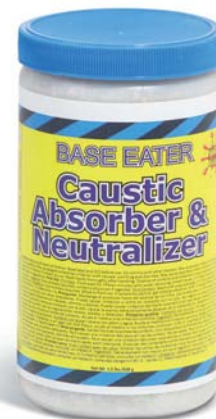

Base Neutralizer

Item #	Description	Size	Qty/Pkg	Absorbs/Pkg
BN1	Base Neutralizer	1.5 lb Shaker	1	0.5 gal.
BN6	Base Neutralizer	1.5 lb Shaker	6	3 gal.



Hydrofluoric Acid Neutralizer

Absorb and solidify dangerous hydrofluoric acid.

- Contains, absorbs and neutralizes hazardous hydrofluoric acid
- Completely destroys the fluoride polymer
- Neutralizer's pellet formula absorbs more and requires less clean-up than adsorbents; does not create "dust clouds"
- Safe, fast-acting and easy to use
- Non-hazardous, non-corrosive and biodegradable



Hydrofluoric Acid Neutralizer

Item #	Description	Size	Qty/Pkg	Absorbs/Pkg
HFN1	Hydrofluoric Acid Neutralizer	1.5 lb Shaker	1	0.5 gal.
HFN6	Hydrofluoric Acid Neutralizer	1.5 lb Shaker	6	3 gal.



Multi-Purpose Neutralizing Spill Kit

Treat a wide range of hazardous chemicals and solvents.

- Safely clean spills of sulfuric, hydrochloric, nitric and phosphoric acid, hydrofluoric acid, caustics and common hydrocarbon solvents all with one kit
- Granular formulas require less clean-up and do not create "dust clouds"
- 1 – Base Neutralizer & Absorber, 1.5 lb shaker
- 1 – HF Neutralizer & Absorber, 1.5 lb shaker
- 1 – Solvent Absorber, 1 lb shaker
- 2 – Acid Neutralizer & Absorber, 1.5 lb shakers
- 2 – Safety Goggles
- 2 – Gloves
- 2 – Aprons
- 2 – Yellow Disposal Bags & Ties
- 1 – Broom and Dust Pan
- Kit packaged in a 3.5 gal portable pail



Multi-Purpose Neutralizing Spill Kit

Item #	Description	Absorbs/Pkg	Refill Kit (contents only)
MPN-KIT	Multi-Purpose Neutralizing Spill Kit	2.5 gal.	n/a

Free-Standing RollRack

Dispense rolls the convenient way with this adjustable holder.

- Folds for storage; locks open for easy moving
- Adjusts from 16", to save space, up to 33" to accommodate larger rolls



Free-standing metal frame adjusts to accept a wide variety of rolls.

Free-Standing RollRack

Item #	Description	Size	Units/Pkg
A-ROLLRACK2	Free-Standing RollRack	For rolls up to 32"W	1

Pad Box

Slash shipping costs and protect your sorbents while in transit.

- Cardboard Pad Box perfectly fits one bale of pads to both protect your sorbents and eliminate any shipping concerns
- Ships in broken-down format to your location for convenience and compact storage

Pad Box

Item #	Description	Size	Units/Pkg
A-PADBOX	Pad Box	15.5"L x 19.25"W x 16"H	1





Floor Grabber Mats stop slips and trips in their tracks!

Adhesive-backing grabs tight to your floor and eliminates shifting and bunching.

FLOOR GRABBER MATS

Stick tight and flat to the floor.

Create exceptional floor safety in your facility with our line of adhesive-backed mats. High-Traffic Mat, Hi-Viz Roll and High-Traffic Carpet Mat stick tight and flat to the floor in your production areas, walkways and entrances. Best of all, you can sweep, mop or vacuum over them as part of your regular floor cleaning program. Choose the version best suited to the needs of your workplace!



NRT100S-BK

NRT100S-HV

NRT25H-GY



Floor Grabber High-Traffic Mat
See pages 52-23



Floor Grabber Hi-Viz Roll
See page 53



Floor Grabber High-Traffic Carpet Mat
See pages 54-55

FLOOR GRABBER HIGH-TRAFFIC

High-traction, adhesive-backed absorbent mat keeps a low profile for exceptional floor safety.

UNIVERSAL ABSORBENCY: Oil, coolants, solvents & water

APPLICATION: Walkways, Entrances

DURABILITY: ● ● ● ● ●

ABSORBENCY: ● ● ● ● ○

AVAILABLE IN: 

FLOOR GRABBER HIGH-TRAFFIC

Barbed needles interlock polypropylene fibers for more durability

MAT CONSTRUCTION

Surface is heat fused for superior durability

Layer of poly backing to keep liquid from passing through to floors

Adhesive backing so mat holds tight but peels up easily

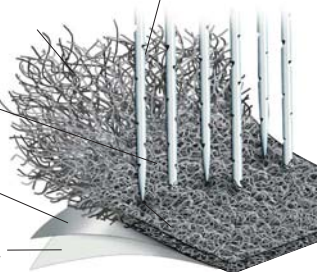

FEATURES AND BENEFITS

- Both feet and forklifts move safely and easily over Floor Grabber High-Traffic Mat's durable interlocking fiber construction, which sticks tight and flat to the floor at all times thanks to its adhesive backing
- Absorbent mat captures water, melting snow, dirt and grease
- Once Mat is in place, it can stay down up to 12 weeks
- Sweep, mop or vacuum over Floor Grabber High-Traffic Mat as part of your regular floor cleaning program — no extra steps required

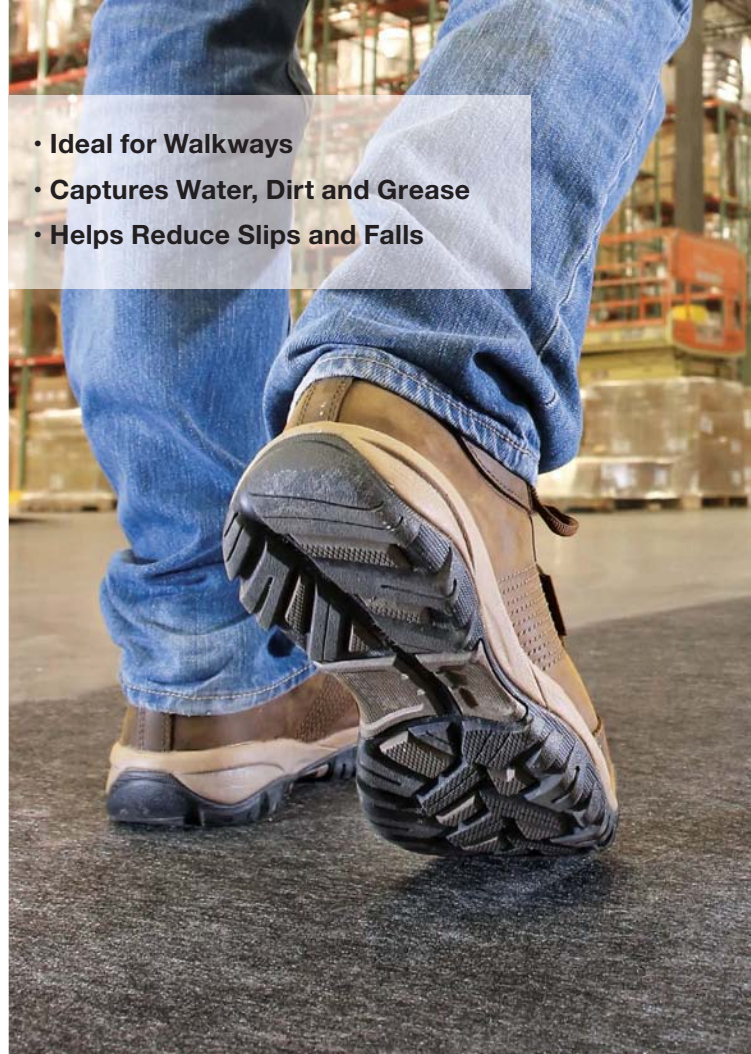

- Ideal for Walkways
- Captures Water, Dirt and Grease
- Helps Reduce Slips and Falls



Adhesive backing sticks tight and flat to the floor for safer walkways while also absorbing leaks, drips and spills.



A high-traction surface is durable enough to handle foot, cart or even forklift traffic.

HYC

Helps you comply with 29 CFR 1910.22(a)(2). See page 123 for details.

Get Stuck on a Smarter Floor Safety Solution

In addition to being painful, slip and fall accidents hurt productivity and increase liability costs. Reduce your risks with our Floor Grabber Adhesive-Backed Mat. It sticks tight and flat to the floor which means no bunching up or sliding to impede walking and working.



CLEARLY MARK YOUR DESIGNATED WALKWAYS.

- High-visibility yellow and black edge pattern meets ANSI standard for floor markings
- Adhesive-backing sticks tight and flat to the floor; pulls up easily when you're done
- A superior alternative to floor paints and tapes



NRT100S-GY
Gray

NRT100S-BK
Black

Floor Grabber™ High-Traffic Universal Rolls

Available in: ■ Black (-BK) ■ Gray (-GY)

Item #	Description	Size	Units/Pkg	Absorbs/Pkg
NRT100S-BK	Floor Grabber Mat	36" x 100'	1	8 gal.
NRT100S-GY	Floor Grabber Mat	36" x 100'	1	8 gal.
NRT50S-BK	Floor Grabber Mat	36" x 50'	1	4 gal.
NRT50S-GY	Floor Grabber Mat	36" x 50'	1	4 gal.
NRT24100S-BK	Floor Grabber Mat	24" x 100'	1	5.3 gal.
NRT24100S-GY	Floor Grabber Mat	24" x 100'	1	5.3 gal.

Please note: SpillTech provides the warranties implied by law only in relation to SpillTech adhesive-backed mats. The customer must ensure that these products are suitable for use in their premises and on their flooring. Further details to relevant terms and conditions can be found on page 119.

NEW



NRT100S-HV
Hi-Viz

Floor Grabber™ Hi-Viz Roll

Item #	Description	Size	Units/Pkg	Absorbs/Pkg
NEW NRT100S-HV	Floor Grabber Hi-Viz	36" x 100'	1	8 gal.



Reduce slip and fall claims by as much as 90%! Floor Grabber High-Traffic Mat is tested and certified by the National Floor Safety Institute (NFSI) as a high-traction surface, which can reduce slip and fall claims by as much as 90% when used as part of a Floor Safety Program.



FLOOR GRABBER HIGH-TRAFFIC CARPET

Opt for extra style points with our Berber Carpet Mat!

UNIVERSAL ABSORBENCY: Oil, coolants, solvents & water

APPLICATION: Walkways, Entrances

DURABILITY: ● ● ● ● ●

ABSORBENCY: ● ● ● ● ○

AVAILABLE IN: 

FLOOR GRABBER HIGH-TRAFFIC CARPET

MAT CONSTRUCTION

Surface is heat fused for superior durability.

Layer of poly backing to keep liquid from passing through to floors.

Adhesive backing so mat holds tight but peels up easily.



FEATURES AND BENEFITS

- Customers and employees will walk safely and easily over the stylish gray Berber carpet surface of our Floor Grabber High-Traffic Carpet Mat — perfect for entrances and lobbies where you want to make a good impression
- Absorbent mat captures water, melting snow, dirt and grease from shoes and even equipment, keeping floors clean and dry; carpet fibers resist staining and fading

HYC Helps you comply with 29 CFR 1910.22(a)(2). See page 123 for details.

- Perfect for Entrances and Lobbies
- Traps Dirt and Moisture
- Helps Reduce Slips and Falls



Stylish Berber carpet tops the adhesive backing layer. It sticks tight and flat to the floor for safer walkways while also absorbing water, dirt, oils and more.



The stylish way to protect your entrances.

Our high-traction, adhesive-backed absorbent mat features a carpeted Berber texture that looks professional and inviting. It has the same low profile for exceptional floor safety as other Floor Grabber Mats. It sticks tight and flat to the floor which means no bunching up or sliding to impede walking and working.



TEXTURED



PROTECT YOUR ENTRANCES AND LOBBIES.

- Absorbent mat captures water, melting snow, dirt and grease from shoes and even equipment, keeping floors clean and dry
- Carpet fibers resist staining and fading



NRT25H-GY

ADHESIVE BACKED

Floor Grabber™ High-Traffic Carpet Universal Rolls

Item #	Description	Size	Units/Pkg	Absorbs/Pkg
NRT25H-GY	Floor Grabber Carpet Mat	36" x 25'	1	6.8 gal.

Please note: SpillTech provides the warranties implied by law only in relation to SpillTech adhesive-backed mats. The customer must ensure that these products are suitable for use in their premises and on their flooring. Further details to relevant terms and conditions can be found on page 119.

NFSI

HIGH-TRACTION

Reduce slip and fall claims by as much as 90%!
 Floor Grabber High-Traffic Mat is tested and certified by the National Floor Safety Institute (NFSI) as a high-traction surface, which can reduce slip and fall claims by as much as 90% when used as part of a Floor Safety Program.



Tuff Rug

Tough StitchBonded mat handles heavy wear and foot traffic.

- Strongest mat stands up to heavy abuse — leave down much longer than regular mat and save money
- Place in busy aisles, walkways and workstations where slippery floors are a concern
- Zigzag stitching adds extra strength so mat won't fray or come apart
- Absorbent polypropylene fibers pull in liquids to keep floors dry
- Absorbs most common industrial liquids: oils, coolants, solvents and water

TUFF Rug®

Item #	Description	Size	Units/Pkg	Absorbs/Pkg
MR2069	HeavyWeight Mat Roll	33" x 150'	1	23.0 gal.

HYC

Helps you comply with 29 CFR 1910.107(b)(3), 29 CFR 1910.107(g)(2) and 29 CFR 1910.22(a)(2). See page 123 for details.

Traffic Tuff Rug

Super-durable Needle-punch mat even stands up to equipment traffic.

- Absorbs light fluids and overspray to keep walkways safe and slip-resistant
- Tough enough to withstand even heavy equipment traffic
- Ideal for lining walkways, replacing rental rugs, and stopping dirt and debris from tracking into clean areas
- Gray color signifies universal sorbency; hides grunge so it stays down longer and saves you money
- PolyBacking gives mat non-skid characteristics (PBR100 only)



Traffic TUFF Rug®

Item #	Description	Size	Units/Pkg	Absorbs/Pkg
NPR150H-GR	HeavyWeight Roll	36" x 150'	1	54.0 gal.
NPR300S-GR	LightWeight Roll	36" x 300'	1	54.0 gal.
PBR100	PolyBacked Roll	36" x 100'	1	13.0 gal.

HYC

Helps you comply with 29 CFR 1910.107(b)(3), 29 CFR 1910.107(g)(2) and 29 CFR 1910.22(a)(2). See page 123 for details.



NPR150H-GR



PBR100

Recycled Tuff Rug

Highly absorbent recycled-fiber mat has walk-on durability.

- Recycled polypropylene and acrylic fibers absorb up to 53 gallons per regular roll or two split rolls.
- High tensile strength stands up to jobs with steady foot traffic
- Dark, multicolored mat looks cleaner longer as fluids are absorbed



RRUG36H



Recycled TUFF Rug®

Item #	Description	Size	Units/Pkg	Absorbs/Pkg
RRUG36H	HeavyWeight Roll	36" x 150'	1	53 gal.
RRUG18H	HeavyWeight Split Rolls	18" x 150'	2	53 gal.



RRUG18H

HYC Helps you comply with 29 CFR 1910.107(b)(3), 29 CFR 1910.107(g)(2) and 29 CFR 1910.22(a)(2). See page 123 for details.



NPRR36H

Recycled Traffic Tuff Rug Roll

Needlepunched construction gives this mat superior tensile strength and durability.

- 100% post-industrial recycled polyester blend
- High tensile strength stands up to jobs with steady foot traffic
- Rolls are ideal for covering large areas



NPRR36H

Recycled Traffic TUFF Rug®

Item #	Description	Size	Units/Pkg	Absorbs/Pkg
NEW NPRR36H	HeavyWeight Roll	36" x 150"	1	50 gal.
NEW NPRR72H	HeavyWeight Roll	72" x 150'	1	100 gal.

HYC Helps you comply with 29 CFR 1910.22(a)(2). See page 123 for details.

Oil-Only TrackMat

Prevent ground contamination during railroad maintenance.

- Economical choice for routine maintenance
- Clear impenetrable poly backing reveals saturation levels at a glance
- Heavy-duty spunbond top layer adds strength and durability for long-term deployment in almost any weather conditions

TRACKMAT

MAT CONSTRUCTION

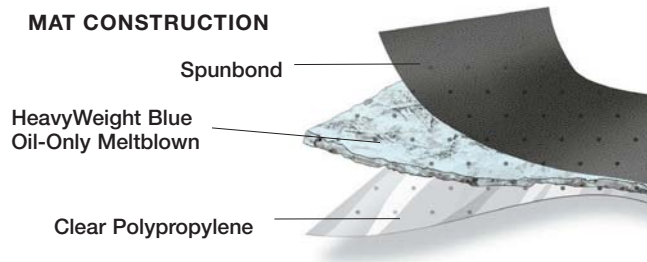

TrackMat Rolls

Item #	Description	Size	Units/Pkg	Absorbs/Pkg
TMAT57	HeavyWeight Roll	57" x 80'	1	63.2 gal.
TMAT19	HeavyWeight Split Rolls	19" x 80'	2	41.7 gal.

HYC

Helps you comply with 29 CFR 1910.120(j)(1), 29 CFR 1910.22(a)(2) and 40 CFR 122.26. See page 123 for details.

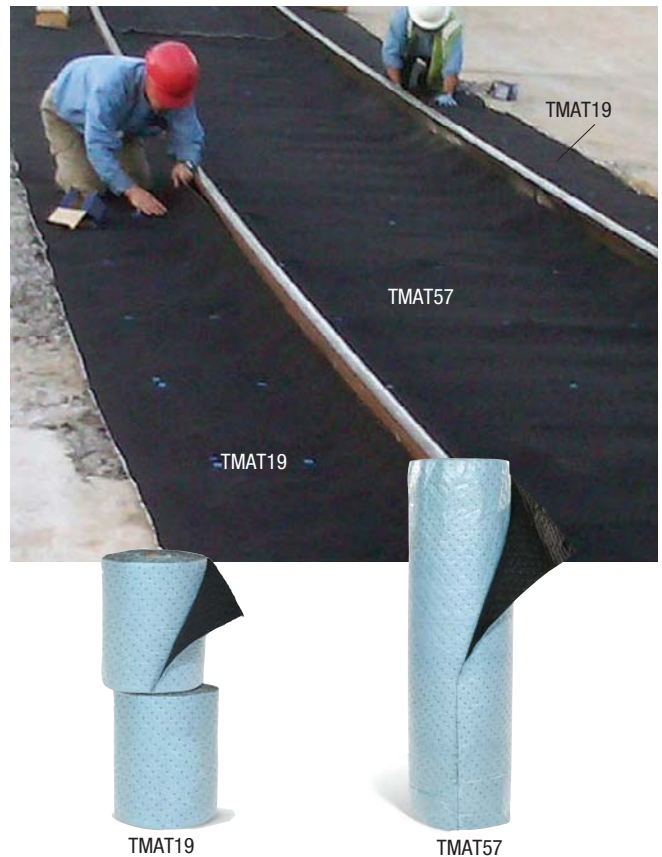

Oil-Only RailRoad Mat

Provides sorbency and spill protection in rail-specific applications.

- A tier of sorbent material is top-layered with needlepunched felt for strength, and then poly-backed with a chemical-resistant material
- Sealed edges prevent leaching and ground contamination

RAILROAD MAT

MAT CONSTRUCTION

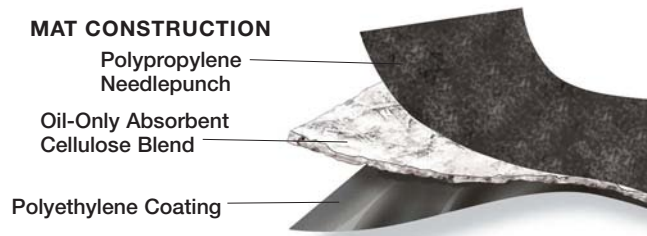

RailRoad Mat

Item #	Description	Size	Units/Pkg	Absorbs/Pkg
RRMAT60	RailRoad Mat Roll	59" x 100'	1	63.0 gal.
RRMAT19	RailRoad Mat Rolls	19" x 100'	2	42.0 gal.

HYC

Helps you comply with 29 CFR 1910.120(j)(1), 29 CFR 1910.22(a)(2) and 40 CFR 122.26. See page 123 for details.





WIPERS

SpillTech Wipers handle anything from wipe-and-toss jobs to heavy-duty tasks.

Since different jobs require different tools, we prioritized variety when putting together our new line of Wipers. As you browse through the full collection, you'll see we've got a Wiper designed for every application. Choose the put-up you like best!



Light-Duty Wipers - 60



Medium-Duty Wipers - 61

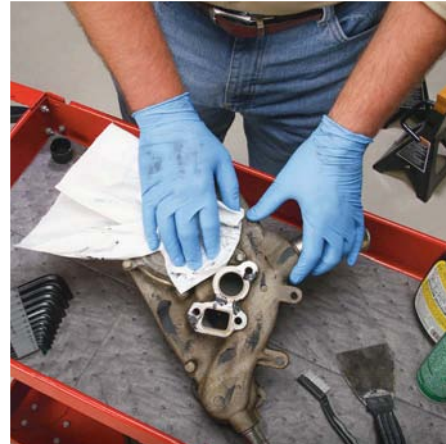

Heavy-Duty Wipers - 62





LIGHT-DUTY WIPERS

Ideal for wipe-and-toss jobs like washing windows and drying or cleaning smooth surfaces.

FLUID: Oils, coolants, solvents & water

APPLICATION: General Cleanup, Economical

DURABILITY: ●●●○○

Series 300 DRC Wipers

- Great for general housekeeping
- Made for jobs like wiping up small spills or cleaning hand tools
- Material is soft enough for wiping hands and face

Series 350 Airlaid Wipers

- Combines thickness, softness and absorbency for general cleanup duties
- Thick, high-loft construction with good wet strength and overall durability
- Non-woven cellulose construction that's soft on hands and faces

Series 300 DRC Wipers

Item #	Style	Color	Size	Units/Pkg	Total Wipers	Composition	Performance Rating
WPR301	Jumbo Roll	White	11.312"W x 13.25"L	950/roll; 1 roll	950	Cellulose with Latex Binder	300

Series 350 Airlaid Wipers

Item #	Style	Color	Size	Units/Pkg	Total Wipers	Composition	Performance Rating
WPR500	1/4-Fold	White	11.5"W x 13"L	25/pack; 36 packs	900	Cellulose	350



WPR301



WPR500



MEDIUM-DUTY WIPERS

For all-around tasks like wiping your hands or face, soaking up small spills or cleaning small parts and tools.

- ▶ **FLUID:** Oils, coolants, solvents & water
- ▶ **APPLICATION:** Cleaning parts, Small spills
- ▶ **DURABILITY:** ● ● ● ● ○

Series 450 DRC Wipers

- Perfect balance of toughness, absorbency and softness
- Constructed of soft, absorbent cellulose fibers with a high-quality binder to increase strength for wet or dry wiping
- Made thick and absorbent to quickly soak up oils, degreasers and other liquids

Series 450 DRC Wipers

Item #	Style	Color	Size	Units/Pkg	Total Wipers	Composition	Performance Rating
WPR308	Roll	White	11.812"W x 6.625"L	415/roll; 2 rolls	830	Cellulose with Latex Binder	450
WPR508	C-Pull Roll	White	8.875"W x 13.25"L	225/roll; 1 roll	225	Cellulose with Latex Binder	450
NEW WIP1302	Pop-up	White	15" W x 9" L	100/box; 9 boxes	900	100% bonded cellulose	450



Heavy-Duty



HEAVY-DUTY WIPERS

Made to handle rough wiping tasks.

FLUID: Oils, coolants, solvents & water

APPLICATION: Heavy-duty jobs, Abrasion-resistant

DURABILITY: ●●●●●

Series 700 Spunlace

- Strong, absorbent, low-lint blend for daily heavy-duty jobs
- Abrasion-resistant; can handle metal chips and rough, jagged surfaces
- Won't shed unwanted fibers with wiping parts
- Withstands solvents, degreasers and cleaning agents

Series 700 Spunlace Wipers

Item #	Style	Color	Size	Units/Pkg	Total Wipers	Composition	Performance Rating
WPR205	Z-Fold	White	12" W x 12.5" L	200/box; 1 box	200	Cellulose & Polyester Blend	700
NEW WIP1105	Roll	Red	13" W x 12" L	475/roll; 1 roll	475	Polypropylene/Woodpulp	700
NEW WIP1000	1/4 fold	Blue	13" W x 14" L	50/pack; 20 packs	1,000	Cellulose & Polyester	700
NEW WIP396	Roll	Blue	15" W x 12" L	440/roll; 1 roll	440	Cellulose & Polyester	700



WPR205



WIP1105



WIP1000



WIP396



 SpillTech

SPILL KITS



The right products for quick response to any spill, anywhere.

Spills happen no matter how hard you try to avoid them. Forklifts knock over drums, tanks are punctured and transporters leak and drip. A quick response is your best weapon in the fight against spills.

Whether you need to clean up a dangerous chemical spill or eliminate a slip-and-fall hazard, you'll be prepared with SpillTech Spill Kits. In this catalog, you'll find a wide range of Spill Kits and accessories to meet your needs. These quality SpillTech products will help you comply with the regulations below. If you don't see what you're looking for, page 78 explains how we can customize a kit to your exact specifications.

-  Universal
-  Oil Only
-  HazMat

65-Gallon Spill Kits

Item #	Description
 SPKU-65	65-Gallon Kit/Universal
 SPKO-65	65-Gallon Kit/Oil-Only
 SPKHZ-65	65-Gallon Kit/HazMat

HYC

Helps you comply with 29 CFR 1910.120(j)(1), 29 CFR 1910.1450(e), *33 CFR 154.1047(c)(2), 40 CFR 263.30 (A), 40 CFR 263.31 and 49 CFR 173.3(c). See page 123 for details.

* Applies to Oil-Only Spill Kits only



95-Gallon Spill Kit

Pre-packed in an X-rated DOT-approved 95-Gallon OverPack.

- 150 – 15" x 19" Pads
- 12 – 3" x 4' Socks
- 2 – Pairs Nitrile Gloves
- 3 – Tubs Plug & Dike
- 4 – Yellow Disposal Bags & Ties
- 1 – Emergency Response GuideBook
- 6 – 3" x 8' Socks
- 7 – 18" x 18" Pillows
- 1 – Spill Kit Label
- 1 – Pair Goggles
- 6 – Tamper-Proof Labels

Absorbs up to **79.7 Gallons**



SPKU-95

95-Gallon Spill kits

Item #	Description	Refill Kit (contents only)
SPKU-95	95-Gallon Kit/Universal	RSPKU-95
SPKO-95	95-Gallon Kit/Oil-Only	RSPKO-95
SPKHZ-95	95-Gallon Kit/HazMat	RSPKHZ-95
A95OVER	Empty 95-Gallon OverPack (see pg. 80)	n/a

95-Gallon Spill Kit with Wheels

X-rated DOT-approved 95-Gallon OverPack rolls to the spill.

- 150 – 15" x 19" Pads
- 12 – 3" x 4' Socks
- 2 – Pairs Nitrile Gloves
- 3 – Tubs Plug & Dike
- 4 – Yellow Disposal Bags & Ties
- 1 – Emergency Response GuideBook
- 6 – 3" x 8' Socks
- 7 – 18" x 18" Pillows
- 1 – Spill Kit Label
- 1 – Pair Goggles
- 6 – Tamper-Proof Labels

Absorbs up to **79.7 Gallons**



SPKU-95-WD

95-Gallon Spill Kits with Wheels

Item #	Description	Refill Kit (contents only)
SPKU-95-WD	95-Gal. Kit/Universal w/Wheels	RSPKU-95
SPKO-95-WD	95-Gal. Kit/Oil-Only w/Wheels	RSPKO-95
SPKHZ-95-WD	95-Gal. Kit/HazMat w/Wheels	RSPKHZ-95
A95OVER-WD	Empty 95-Gal. OverPack w/ Wheels (see pg. 80)	n/a

65-Gallon Spill Kit

Pre-packed in an X-rated DOT-approved 65-Gallon OverPack.

- 40 – 15" x 19" Pads
- 6 – 3" x 8' Socks
- 10 – 3" x 4' Socks
- 6 – 18" x 18" Pillows
- 2 – Pairs Nitrile Gloves
- 3 – Yellow Disposal Bags & Ties
- 1 – Pair Safety Goggles
- 1 – Spill Kit Label
- 6 – Tamper-Proof Labels
- 1 – Emergency Response GuideBook

Absorbs
up to
43.8
Gallons

65-Gallon Spill Kits

Item #	Description	Refill Kit (contents only)
SPKU-65	65-Gallon Kit/Universal	RSPKU-65
SPKO-65	65-Gallon Kit/Oil-Only	RSPKO-65
SPKHZ-65	65-Gallon Kit/HazMat	RSPKHZ-65
A65OVER	Empty 65-Gallon OverPack (see pg. 80)	n/a

SPKO-65



55-Gallon Spill Kit

Pre-packed in an X-rated 55-Gallon OverPack.

- 100 – 15" x 19" Pads
- 10 – 3" x 4' Socks
- 5 – 18" x 18" Pillows
- 2 – Pairs Nitrile Gloves
- 2 – Pairs Safety Goggles
- 1 – Emergency Response GuideBook
- 4 – Disposal Bags & Ties
- 6 – Tamper Proof Seals

Absorbs
up to
48.9
Gallons

55-Gallon Spill Kits

Item #	Description	Refill Kit (contents only)
SPKU-55	55-Gallon Kit/Universal	RSPKU-55
SPKO-55	55-Gallon Kit/Oil-Only	RSPKO-55
SPKHZ-55	55-Gallon Kit/HazMat	RSPKHZ-55
A55DRUM	Empty 55-Gallon Open-Head Poly Drum w/Ring (see pg. 80)	n/a

SPKO-55



50-Gallon Spill Kit

X-rated DOT-approved 50-Gallon OverPack with wheels.

- 100 – 15" x 19" Pads
- 6 – 3" x 4' Socks
- 4 – 18" x 18" Pillows
- 2 – Pairs Nitrile Gloves
- 5 – Yellow Disposal Bags & Ties
- 1 – Pair Safety Goggles
- 1 – Emergency Response GuideBook
- 1 – 6" Light Stick
- 1 – Spill Kit Label
- 6 – Tamper-Proof Labels

Absorbs
up to
43.3
Gallons

50-Gallon Spill Kits with Wheels

Item #	Description	Refill Kit (contents only)
SPKU-50-WD	50-Gal. Kit/Universal w/wheels	RSPKU-50
SPKO-50-WD	50-Gal. Kit/Oil-Only w/wheels	RSPKO-50
SPKHZ-50-WD	50-Gal. Kit/HazMat w/wheels	RSPKHZ-50
A50OVER-WD	Empty 50-Gal. OverPack w/wheels (see pg. 80)	n/a

SPKHZ-50-WD



30-Gallon Spill Kit

Pre-packed in an X-rated DOT-approved 30-Gallon OverPack.

- 25 – 15" x 19" Pads
- 4 – 3" x 8' Socks
- 4 – 18" x 18" Pillows
- 1 – Pair Nitrile Gloves
- 1 – Pair Safety Goggles
- 5 – Yellow Disposal Bags & Ties
- 6 – Tamper-Proof Labels
- 1 – Spill Kit Label
- 1 – Emergency Response GuideBook

Absorbs up to **23.1 Gallons**



30-Gallon Spill Kit

Item #	Description	Refill Kit (contents only)
SPKU-30	30-Gallon Kit/Universal	RSPKU-30
SPKO-30	30-Gallon Kit/Oil-Only	RSPKO-30
SPKHZ-30	30-Gallon Kit/HazMat	RSPKHZ-30
A30OVER	Empty 30-Gallon OverPack (see pg. 80)	n/a

20-Gallon Spill Kit

Pre-packed in an X-rated DOT-approved 20-Gallon OverPack.

- 25 – 15" x 19" Pads
- 4 – 3" x 4' Socks
- 2 – 18" x 18" Pillows
- 1 – Pair Nitrile Gloves
- 4 – Yellow Disposal Bags & Ties
- 1 – Pair Safety Goggles
- 1 – Spill Kit Label
- 6 – Tamper-Proof Labels

Absorbs up to **15.2 Gallons**



20-Gallon Spill Kits

Item #	Description	Refill Kit (contents only)
SPKU-20	20-Gallon Kit/Universal	RSPKU-20
SPKO-20	20-Gallon Kit/Oil-Only	RSPKO-20
SPKHZ-20	20-Gallon Kit/HazMat	RSPKHZ-20
A20OVER	Empty 20-Gallon OverPack (see pg. 80)	n/a

10-Gallon Spill Kits

Big absorbency packed in a small kit.

- 20 – 15" x 19" Pads
- 3 – 3" x 4' Socks
- 1 – 8" x 18" Pillows
- 1 – Pair Nitrile Gloves
- 1 – Pair Safety Goggles
- 2 – Yellow Disposal Bags & Ties
- 6 – Tamper-Proof Labels
- 1 – Spill Kit Label

Absorbs up to **9.5 Gallons**



10-Gallon Spill Kit

Item #	Description	Refill Kit (contents only)
SPKU-10	10-Gal. Kit/Universal	RSPKU-10
SPKO-10	10-Gal. Kit/Oil-Only	RSPKO-10
SPKHZ-10	10-Gal. Kit/HazMat	RSPKHZ-10
A10DRUM	Empty 10-Gal. OverPack (see pg 80)	n/a

50-Gallon Wheeled Spill Kit

Wheel your absorbents right to the site of the spill.

◆ Universal

- 100 – 15" x 19" Pads
- 6 – 3" x 4' Socks
- 4 – 3" x 12' Socks
- 2 – Pairs Nitrile Gloves
- 4 – Yellow Disposal Bags & Ties
- 2 – Pair Safety Goggles
- 2 – Coveralls
- 1 – 3" X 5" Vinyl Spill Kit Label
- 6 – 6" X 2" Tamper-Proof Seals
- 3 – 28 oz Shaker SuperSorb
- 4 – 25/pkg Wipers
- 1 – Emergency Response GuideBook

Absorbs up to 45.9 gallons

◆ Oil-Only

- 100 – 15" x 19" Pads
- 6 – 3" x 4' Socks
- 4 – 3" x 12' Socks
- 2 – Pairs Nitrile Gloves
- 4 – Yellow Disposal Bags & Ties
- 2 – Pair Safety Goggles
- 2 – Coveralls
- 1 – 3" X 5" Vinyl Spill Kit Label
- 6 – 6" X 2" Tamper-Proof Seals
- 3 – 28 oz Shaker SuperSorb
- 4 – 25/pkg Wipers
- 1 – Emergency Response GuideBook

Absorbs up to 45.9 gallons

◆ HazMat

- 100 – 15" x 19" Pads
- 6 – 3" x 4' Socks
- 4 – 3" x 12' Socks
- 2 – Pairs Nitrile Gloves
- 4 – Yellow Disposal Bags & Ties
- 2 – Pair Safety Goggles
- 2 – Coveralls
- 1 – 3" X 5" Vinyl Spill Kit Label
- 6 – 6" X 2" Tamper-Proof Seals
- 3 – 32 oz Acid Neutralizing Shaker
- 1 – pH Test Strip Roll
- 1 – Emergency Response GuideBook

Absorbs up to 44.7 gallons



SPKU-CAN-WD

50-Gallon Wheeled Spill Kit

Item #	Description	Refill Kit (contents only)
◆ SPKU-CAN-WD	50-Gal. Kit/Universal w/wheels	RSPKU-CAN
◆ SPKO-CAN-WD	50-Gal. Kit/Oil-Only w/wheels	RSPKO-CAN
◆ SPKHZ-CAN-WD	50-Gal. Kit/HazMat w/wheels	RSPKHZ-CAN
A50CAN-WD	Empty 50-Gal. Container w/wheels (see pg 80)	n/a

Spill Kaddie Kit

Interior shelves and compartments keep supplies organized.

- 100 – 10" x 14" Pads
- 6 – 3" x 4' Socks
- 4 – 8" x 18" Pillows
- 2 – Pairs Nitrile Gloves
- 5 – Yellow Disposal Bags & Ties
- 1 – Pair Safety Goggles
- 1 – Emergency Response GuideBook
- 1 – 6" Light Stick
- 1 – Spill Kit Label

Spill Kaddie Kits

Item #	Description	Refill Kit (contents only)
◆ SPKU-KAD2	Spill Kaddie Kit/Universal	RSPKU-KAD
◆ SPKO-KAD2	Spill Kaddie Kit/Oil-Only	RSPKO-KAD
◆ SPKHZ-KAD2	Spill Kaddie Kit/HazMat	RSPKHZ-KAD
A-KADDIE	Empty Spill Kaddie (see pg. 79)	n/a



SPKHZ-KAD2

**Can't
Miss Spill
Response!**



HI VIZ SPILL KIT

Prepacked hi viz containers are easy to see and hold all of the sorbents and supplies you need for quick spill response.

95-Gallon

Be prepared for fast response with a high-visibility kit!

- 150 – 15" x 19" Pads
- 12 – 3" x 4' Socks
- 6 – 3" x 8" Socks
- 7 – 18" x 18" Pillows
- 2 – Pairs Nitrile Gloves
- 4 – Yellow Disposal Bags & Ties
- 1 – Pair Safety Goggles
- 1 – 3" X 5" Vinyl Spill Kit Label
- 6 – 6" X 2" Tamper-Proof Seals
- 3 – 1 lb Epoxy Putty
- 1 – Emergency Response GuideBook



SPKU-95-HV

95-Gallon Hi Viz Spill Kit

Item #	Description	Refill Kit (contents only)
◆ SPKU-95-HV	95-Gal. Hi Viz Kit/Universal	RSPKU-95
◆ SPKO-95-HV	95-Gal. Hi Viz Kit/Oil-Only	RSPKO-95
◆ SPKHZ-95-HV	95-Gal. Hi Viz Kit/HazMat	RSPKHZ-95
A95OVER-HV	Empty 95-Gal. Hi Viz OverPack	n/a

30-Gallon

Be prepared for fast response with a high-visibility kit!

- 25 – 15" x 19" Pads
- 4 – 3" x 8' Socks
- 4 – 18" x 18" Pillows
- 1 – Pairs Nitrile Gloves
- 5 – Yellow Disposal Bags & Ties
- 1 – Pair Safety Goggles
- 1 – 3" X 5" Vinyl Spill Kit Label
- 6 – 6" X 2" Tamper-Proof Seals
- 1 – Emergency Response GuideBook



SPKU-30-HV

30-Gallon Hi Viz Spill Kit

Item #	Description	Refill Kit (contents only)
◆ SPKU-30-HV	30-Gal. Hi Viz Kit/Universal	RSPKU-30
◆ SPKO-30-HV	30-Gal. Hi Viz Kit/Oil-Only	RSPKO-30
◆ SPKHZ-30-HV	30-Gal. Hi Viz Kit/HazMat	RSPKHZ-30
A30OVER-HV	Empty 30-Gal. Hi Viz OverPack	n/a

65-Gallon

Bright green drum stands out, even in low light conditions.

- 40 – 15" x 19" Pads
- 10 – 3" x 4' Socks
- 6 – 3" x 8" Socks
- 6 – 18" x 18" Pillows
- 2 – Pairs Nitrile Gloves
- 3 – Yellow Disposal Bags & Ties
- 1 – Pair Safety Goggles
- 1 – 3" X 5" Vinyl Spill Kit Label
- 6 – 6" X 2" Tamper-Proof Seals
- 1 – Emergency Response GuideBook



SPKHZ-65-HV

65-Gallon Hi Viz Spill Kit

Item #	Description	Refill Kit (contents only)
◆ SPKU-65-HV	65-Gal. Hi Viz Kit/Universal	RSPKU-65
◆ SPKO-65-HV	65-Gal. Hi Viz Kit/Oil-Only	RSPKO-65
◆ SPKHZ-65-HV	65-Gal. Hi Viz Kit/HazMat	RSPKHZ-65
A65OVER-HV	Empty 65-Gal. Hi Viz OverPack	n/a

20-Gallon

Bright green drum stands out, even in low light conditions.

- 25 – 15" x 19" Pads
- 4 – 3" x 4' Socks
- 2 – 18" x 18" Pillows
- 1 – Pairs Nitrile Gloves
- 4 – Yellow Disposal Bags & Ties
- 1 – Pair Safety Goggles
- 1 – 3" X 5" Vinyl Spill Kit Label
- 6 – 6" X 2" Tamper-Proof Seals



SPKU-20-HV

20-Gallon Hi Viz Spill Kit

Item #	Description	Refill Kit (contents only)
◆ SPKU-20-HV	20-Gal. Hi Viz Kit/Universal	RSPKU-20
◆ SPKO-20-HV	20-Gal. Hi Viz Kit/Oil-Only	RSPKO-20
◆ SPKHZ-20-HV	20-Gal. Hi Viz Kit/HazMat	RSPKHZ-20
A20OVER-HV	Empty 20-Gal. Hi Viz OverPack	n/a



Absorbs
up to
109.9
Gallons

SPKO-CART5



8" Wheel

5" Wheel

Spill Cart Kit

Easy-to-locate container rolls quickly to a spill site.

◆ Universal

- 160 – 15" x 19" Pads
- 10 – 3" x 8' Socks
- 4 – Yellow Disposal Bags & Ties
- 1 – Pair Safety Goggles
- 1 – Spill Kit Label
- 30 – 3" x 4' Socks
- 100 – Wipers
- 1 – Pair Nitrile Gloves
- 1 – Emergency Response GuideBook
- 6 – Tamper Proof Labels

Absorbs up to 88.56 gallons

◆ Oil-Only

- 100 – 15" x 19" Pads
- 2 – 8" x 20' Sock/Net Booms
- 2 – 6" x 16" x 21" Net Pillows
- 1 – Pair Nitrile Gloves
- 1 – Emergency Response GuideBook
- 6 – Tamper Proof Labels
- 4 – 5" x 10' Socks
- 4 – 8" x 18" Pillows
- 4 – Yellow Disposal Bags & Ties
- 1 – Pair Safety Goggles
- 1 – Spill Kit Label

Absorbs up to 109.9 gallons

◆ HazMat

- 100 – 15" x 19" Pads
- 3 – 3" x 8' Socks
- 7 – 18" x 18" Pillows
- 1 – Pair Nitrile Gloves
- 1 – Emergency Response GuideBook
- 6 – Tamper Proof Labels
- 15 – 3" x 4' Socks
- 2 – 5" x 10' Sock/Net Booms
- 4 – Yellow Disposal Bags & Ties
- 1 – Pair Safety Goggles
- 1 – Spill Kit Label

Absorbs up to 86 gallons

Spill Cart Kits

Item #	Description	Refill Kit (contents only)
◆ SPKU-CART5	Spill Cart Kit/Universal w/ 5" Wheels	RSPKU-CART
◆ SPKU-CART8	Spill Cart Kit/Universal w/ 8" Wheels	RSPKU-CART
◆ SPKO-CART5	Spill Cart Kit/Oil-Only w/ 5" Wheels	RSPKO-CART
◆ SPKO-CART8	Spill Cart Kit/Oil-Only w/ 8" Wheels	RSPKO-CART
◆ SPKHZ-CART5	Spill Cart Kit/HazMat w/ 5" Wheels	RSPKHZ-CART
◆ SPKHZ-CART8	Spill Cart Kit/HazMat w/ 8" Wheels	RSPKHZ-CART
A-UTILITYBOX5	Empty Utility Box w/ 5" Wheels (pg.79)	n/a
A-UTILITYBOX8	Empty Utility Box w/ 8" Wheels (pg.79)	n/a



Packed with absorbents to handle large spills.



Forklift Spill Kits

Easy access for quick response to accidental spills.

- 20 – 15" X 19" Pads
- 3 – 3" X 4' Socks
- 1 – Pair Nitrile Gloves
- 1 – Safety Goggles
- 2 – Yellow Disposal Bags & Ties
- 1 – 10" dia x 22" Forklift Bag

Forklift Spill Kits

Item #	Description	Refill Kit (contents only)
SPKU-LIFT	Spill Kit/Universal	n/a
SPKO-LIFT	Spill Kit/Oil-Only	n/a
SPKHZ-LIFT	Spill Kit/HazMat	n/a

Absorbs
up to
8.3
Gallons



SPKU-LIFT

Absorbs
up to
8.3
Gallons



SPKO-LIFT

Absorbs
up to
8.3
Gallons



SPKHZ-LIFT

**Quick
Response is
in the Bag!**



SPKU-BLK-BG

DUFFLE BAG SPILL KITS

Packed for on-the-go spill response.

Duffle Bag Spill Kits

Ideal for use in fleet vehicles.

- 60 – 15" x 19" Pads
- 8 – 3" x 4' Socks
- 2 – 18" x 18" Pillows
- 2 – Pair Nitrile Gloves
- 1 – Pair Safety Goggles
- 4 – Yellow Disposal Bags & Ties
- 1 – Emergency Response GuideBook

Duffle Bag Spill Kits

Item #	Description	Refill Kit (contents only)
SPKU-DUFF	Duffle Bag/Universal	n/a
SPKO-DUFF	Duffle Bag/Oil-Only	n/a
A-DUFFLE	Empty Yellow Duffle Bag (see pg. 79)	n/a

Compact nylon duffle bag in highly visible yellow color.



SPKU-DUFF



Large soft-sided duffle bag offers grab-and-go convenience, with a secure zipper closure to protect sorbents from dirt.

Black Bag Spill Kits

Store sorbents for easy access during a spill emergency.

- 15 – 10" x 14" Pads
- 2 – 3" x 4' Socks
- 2 – 18" x 18" Pillows
- 1 – Glow Light Stick
- 1 – Pair Nitrile Gloves
- 1 – Pair Safety Goggles
- 2 – Yellow Disposal Bags & Ties

Black Bag Spill Kits

Item #	Description	Refill Kit (contents only)
SPKU-BLK-BG	Black Bag/Universal	n/a
SPKO-BLK-BG	Black Bag/Oil-Only	n/a
A-BLACKBAG	Empty Black Bag (see pg. 79)	n/a

Compact polyester duffle bag in grime-hiding black color.



SPKO-BLK-BG



Ideal for use in fleet vehicles, this compact black bag helps save time and facilitates a quicker spill response.



Tote Spill Kits

Compact design keeps you prepared for fast response.

- Durable, water-resistant vinyl bag with zipper keeps contents clean and dry
- Packed with a variety of quality SpillTech® sorbents
- Bright green kit stands out, even in low light conditions
- Compact design is perfect for use in trucks or other equipment

- 10 – 15" x 19" Pads
- 2 – 3" x 4" Socks
- 1 – Pair Nitrile Gloves
- 1 – Pair Safety Goggles
- 2 – Yellow Disposal Bags & Ties



SPKO-GTOTE

Tote Spill Kits

Item #	Description	Refill Kit (contents only)
SPKU-GTOTE	Universal Tote Spill Kit	n/a
SPKO-GTOTE	Oil-Only Tote Spill Kit	n/a
SPKHZ-GTOTE	HazMat Tote Spill Kit	n/a
A-GTOTE	Empty Tote Bag (green)	n/a



Foil Bag Spill Kits

Be prepared for fast spill response with a single-use puncture-proof bag!

- Self-contained, compact Kit provides easy access when quick response is necessary
- Heat-sealed foil bag
- Bag is puncture-proof, water- and UV-resistant
- Includes a variety of sorbents to handle smaller spills of oils, coolants, solvents or water that truckers encounter on a regular basis

- 15 – 15" x 19" Pads
- 3 – 3" x 4" Socks
- 1 – Pair Nitrile Gloves
- 1 – Pair Safety Goggles
- 2 – Yellow Disposal Bags & Ties



Foil Bag Spill Kit

Item #	Description	Refill Kit (contents only)
NEW SPKU-FOILB	Fleet Kit/Universal	n/a
NEW SPKO-FOILB	Fleet Kit/Oil-Only	n/a
NEW SPKHZ-FOILB	Fleet Kit/HazMat	n/a

Yellow Emergency Kit

Compact design is perfect for use in trucks or equipment.

- 10 – 15" x 19" Pads
- 1 – Pairs Nitrile Gloves
- 2 – Yellow Disposal Bags & Ties
- 2 – 3" x 4' Socks
- 1 – Safety Goggles
- 1 – Yellow Tote Bag

Absorbs
up to
4.1
Gallons



SPKO-YBAG

Yellow Emergency Kit

Item #	Description	Refill Kit (contents only)
SPKU-YBAG	Yellow Emergency Kit/Universal	n/a
SPKO-YBAG	Yellow Emergency Kit/Oil-Only	n/a
SPKHZ-YBAG	Yellow Emergency Kit/HazMat	n/a

Orange Emergency Kit

Durable hi-viz bag with zipper keeps contents dry.

- 10 – 15" x 19" Pads
- 1 – Pairs Nitrile Gloves
- 2 – Yellow Disposal Bags & Ties
- 2 – 3" x 4' Socks
- 1 – Safety Goggles
- 1 – Orange Tote Bag

Absorbs
up to
4.1
Gallons



SPKO-OBAG

Orange Emergency Kit

Item #	Description	Refill Kit (contents only)
SPKU-OBAG	Orange Emergency Kit/Universal	n/a
SPKO-OBAG	Orange Emergency Kit/Oil-Only	n/a

Fleet Kit

Handle small spills on the road — perfect for fleet vehicles.

- 50 – 10" x 14" Pads
- 1 – 1 lb. Plug & Dike Epoxy Putty
- 2 – Yellow Disposal Bags & Ties
- 2 – Pairs Nitrile Gloves
- 1 – Yellow Nylon "Spill Responder" Zippered Tote Bag
- 2 – 3" x 4' Socks
- 9 – Assorted Wooden Plugs
- 1 – Safety Goggles

Absorbs
up to
10.7
Gallons



SPKO-FLEET

Fleet Kit

Item #	Description	Refill Kit (contents only)
SPKU-FLEET	Fleet Kit/Universal	n/a
SPKO-FLEET	Fleet Kit/Oil-Only	n/a
SPKHZ-FLEET	Fleet Kit/HazMat	n/a
A-YTOTE	Empty Tote Bag (yellow; see pg.79)	n/a

Absorbs
up to
4.6
Gallons



SPKU-5

5-Gallon Spill Kit

Be prepared for fast response with a variety of sorbents.

- 10 – 15" x 19" Pads
- 2 – Yellow Disposal Bags & Ties
- 1 – Pair Safety Goggles
- 1 – White 5-Gallon OverPack (1H2/Y1.5/30)
- 2 – 3" x 4' Socks
- 1 – Pair Nitrile Gloves
- 1 – Vinyl Spill Kit Label
- 6 – Tamper Proof Seals

5-Gallon Spill Kits

Item #	Description	Refill Kit (contents only)
SPKU-5	5-Gallon Kit/Universal	n/a
SPKO-5	5-Gallon Kit/Oil-Only	n/a
SPKHZ-5	5-Gallon Kit/HazMat	n/a
A5OVER	Empty 5-Gallon Pail (see pg. 80)	n/a

Absorbs
up to
8.3
Gallons



SPKHZ-TRK

Trucker Spill Kit

Tackle smaller spills that truckers encounter on a regular basis.

- 20 – 15" x 19" Pads
- 2 – Yellow Disposal Bags & Ties
- 1 – Safety Goggles
- 1 – Clear Vinyl Zippered Bag
- 3 – 3" x 4' Socks
- 1 – Pair Nitrile Gloves
- 1 – Vinyl Spill Kit Label

Trucker Spill Kit

Item #	Description	Refill Kit (contents only)
SPKU-TRK	Trucker Kit/Universal	n/a
SPKO-TRK	Trucker Kit/Oil-Only	n/a
SPKHZ-TRK	Trucker Kit/HazMat	n/a

Absorbs
up to
3.7
Gallons



SPKO-YTB

Single Use Spill Kits

Small, economical kit that's great for grab-and-go convenience.

- 10 – 15" x 18" Pads
- 1 – Pairs Nitrile Gloves
- 1 – Yellow Disposal Bag & Tie
- 2 – 3" x 4' Socks
- 1 – Yellow Tinted Bag

Single Use Spill Kits

Item #	Description	Refill Kit (contents only)
SPKU-YTB	Spill Kit/Universal	n/a
SPKO-YTB	Spill Kit/Oil-Only	n/a

Wall Cabinet Spill Kit



SPKU-WCAB

Absorbs
up to
22.7
Gallons

Store spill supplies where you need them.

Universal Spill Kit includes a variety of sorbents to handle spills of oils, coolants, solvents or water. Prepacked in a wall-mountable steel cabinet.

- 75 – 10" x 14" Pads
- 2 – 3" x 4' Socks
- 10 – 10" x 10" Pillows
- 50 – 13" x 11.5" Wipers
- 4 – Yellow Disposal Bags & Ties
- 1 – Yellow Steel Wall Mounted Cabinet with two adjustable shelves

Universal Wall Mount Cabinet Spill Kit

Item #	Description	Refill Kit (contents only)
SPKU-WCAB	Universal Wall Cabinet Spill Kit	RSPKU-WCAB
A-WCAB	Empty Wall Mount Cabinet	n/a

Battery Acid Kit

Get everything you need to handle a battery acid spill in this pre-packed, X-rated DOT-approved 20-Gallon OverPack.

- 40 – 15" x 19" Pads
- 3 – 3" x 4' Socks
- 3 – 18" x 18" Pillows
- 2 – 2-lb. shaker Acid Neutralizing Sorbent Powder
- 4 – Yellow Disposal Bags & Ties
- 1 – Pair Neoprene Gloves
- 1 – Safety Goggles
- 1 – Vinyl Spill Kit Label
- 1 – Yellow 20-Gallon OverPack (1H2/X75/S)
- 6 – TamperProof Seals

Battery Acid Kit

Item #	Description	Refill Kit (contents only)
SPKHZ-BATT	HazMat Battery Acid Spill Kit	RSPKHZ-BATT
A200VER	Empty 20-Gallon OverPack (see pg. 80)	n/a



Absorbs
up to
21.4
Gallons

SPKHZ-BATT

Personal Protection Kit

Keep safe at the site of the spill using this convenient grab-and-go Personal Protection Kit.

- 3 – Tyvek Coveralls
- 3 – Pairs Latex Boots
- 3 – Pairs Nitrile Gloves
- 3 – Goggles
- 3 – Disposal Bags & Ties
- 1 – Emergency Response GuideBook
- 1 – Yellow Zip Closure Bag

Personal Protection Spill Kit

Item #	Description	Refill Kit (contents only)
PPE-KIT	Personal Protection Spill Kit	n/a



PPE-KIT

Mercury Kit

Clean up hazardous mercury spills and suppress harmful vapors with this specialized Mercury Spill Kit.

- 1 – Mercury Absorbent Powder
- 1 – Goggles
- 1 – Mercury Cleanup Wipers
- 1 – Dustpan & Hand Broom
- 1 – Disposal Bags
- 1 – 18 mil. Latex Gloves

Mercury Kit

Item #	Description	Refill Kit (contents only)
MERC-KIT2	Mercury Spill Kit	n/a



Absorbs
up to
35.3
Ounces

MERC-KIT2

More neutralizing kits available on page 48.

BUILD A CUSTOM SPILL KIT WITH JUST WHAT YOU NEED!

Get the perfect Spill Kit for your application.

If you can't find exactly what you need in our selection of pre-packed kits, we'll be glad to build one to your specifications. Answer five simple questions (at right) to help choose the type and quantity of sorbents you require, the accessories to make the response safer and the container that will work best. There's no extra charge for this service, so it's an easy way to customize your spill response plan and stock only the sorbents and PPE you really need. After you've made your list, just contact your local Distributor and we'll do the rest!



1. How much do you need to absorb?

What is your worst-case scenario? You'll need enough sorbents to clean up the maximum amount, whether it's one gallon or one hundred.



2. What liquid are you absorbing?

For multiple everyday liquids, use Universal. To soak up oil and repel water, choose Oil-Only. To alert workers to a dangerous spill, use HazMat.



3. What type of spills do you deal with?

Slops and spills use pads for quick wiping and cleanup. Drum/tank leaks need more socks for diking and Plug & Dike epoxy to stop the flow. Large-volume spills require booms for containment and pillows for more sorbency.

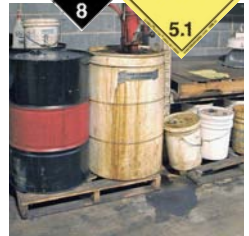

4. What type of PPE and accessories will you need?

Most spills call for boots, gloves and goggles. Will you need coveralls? How much chemical protection do you need? How often will you have to replace disposable items?



5. What type of container will you need?

For removing saturated sorbents, use a UN-rated Overpack/Salvage Drum. Stationary Kits can go in a flat-bottom Overpack. Movable kits require a kaddie or wheeled overpack.



A-UTILITYBOX5



A-KADDIE2

A-YTOTE



A95OVER-WD



Spill Kaddie

Hi-viz Spill Kaddie arrives empty and ready too fill with your favorite absorbents.

- Cart's roomy inside with enough supplies for up to 20 gallons-worth of absorption; helps you stay ready to respond to small or medium spills
- Front-loading doors open wide for grabbing supplies
- Cart rolls easily across uneven surfaces on the 7-inch anti-sag wheels



A-KADDIE2

Spill Cart

Roll your sorbents right to a spill in this heavy-duty cart.

- Fits easily through doorways and aisles and can also be moved with a forklift
- UV-inhibited polyethylene can be used outdoors and is durable to withstand rough handling



A-UTILITYBOX5

Tote Bag

Fill this sturdy nylon Tote Bag with sorbents for on-the-go spill security.

- Small soft-sided duffel bag offers grab-and-go convenience and is ideal for use in fleet vehicles



A-YTOTE

Duffel Bag

Get easy access to sorbents during a spill emergency.

- Large soft-sided duffel bag offers grab-and-go convenience and is ideal for use in fleet vehicles



A-DUFFLE

Black Bag

Large Bag perfect for on-the-go spills.

- Grime-hiding black bag stores sorbent products (not included) for easy access during a spill emergency



A-BLACKBAG

Tote Bags

Durable bag with zipper keeps contents clean and dry.

- Compact design is perfect for use in trucks or other equipment
- Also comes in yellow (A-YBAG)



A-OBAG

Wall Mount Cabinet

Mounts easily to just about any wall — no brackets needed!

- Durable safety yellow powder coat finish with "Spill Response Center" clearly labeled across the front



A-WCAB

Containers

Item #	Description	Size
A-KADDIE2	Empty Spill Kaddie	38"H x 24"W x 23.5"D
A-UTILITYBOX5	Utility Box w/ 5" Wheels	36.5"H x 48"W x 31"D
A-UTILITYBOX8	Utility Box w/ 8" Wheels	39.5"H x 48"W x 31"D
A-GTOTE	Empty Tote Bag, Green	20"L x 15"W x 4"D
A-YTOTE	Empty Tote Bag, Yellow	20"L x 17"W x 8"D
A-DUFFLE	Empty Yellow Duffel Bag	40"L x 12"W x 12"H
A-BLACKBAG	Empty Black Bag	18"L x 11"W x 11"H
A-OBAG	Empty Orange Tote Bag	12"L x 18"H x 4"D
A-YBAG	Empty Yellow Tote Bag	12"L x 18"H x 4"D
A-WCAB	Empty Wall Mount Cabinet	12.75"L x 13.75"W x 30"H

OverPacks and OverPack Salvage Drums

Whether you're building a spill kit, collecting used absorbents or shipping damaged containers, we'll get you packed.

Our OverPacks are sturdy, chemical-resistant for years of use and come in many sizes.

Most offer integrated forklift ledges or handles, which make them easy to lift, move or carry.

Avoid the extra expense of a dolly when you buy a wheeled version, which provides you with great versatility in a single integrated product.

When you need the additional confidence of an OverPack Salvage Drum for shipping, ours are UN X- or Y- Rated and are DOT Certified.



OverPacks & OverPack Salvage Drums

Item #	Description	Size	UN Rating
A95OVER	95-Gallon OverPack Salvage Drum	32" Dia., 41.5"H	1H2/X295/S
A95OVER-RC	95-Gallon Recycled OverPack Salvage Drum	32.25" Dia., 41.5"H	1H2/Y345/S
A95OVER-WD	95-Gallon Wheeled OverPack Salvage Drum	32" Dia., 47.5"H	1H2/X113/S
A65OVER	65-Gallon OverPack Salvage Drum	28.25" Dia., 37.5"H	1H2/X200/S
A55DRUM	55-Gallon OverPack	24" Dia., 40"H	1H2/X100/S
A50OVER-WD	50-Gallon Wheeled OverPack Salvage Drum	24.5" Dia., 45.5"H	1H2/X125/S
A50CAN-WD	50-Gallon Wheeled OverPack	29" x 23.5" x 36.75"	n/a
A300OVER	30-Gallon OverPack Salvage Drum	23" Dia., 30"H	1H2/X100/S
A200OVER	20-Gallon OverPack Salvage Drum	23" Dia., 19.5"H	1H2/X66/S
A10DRUM	10-Gallon OverPack	15" Dia., 18" H	1H2/Y60/S
A5OVER	5-Gallon OverPack	12" Dia., 16.75"H	1H2/Y1.5/30

Smart Selection Tip:

Overpacks vs. Salvage Drums

What's the difference?

An **OverPack** is an outer packaging that holds and protects one or more intact, undamaged smaller containers of hazardous materials. A **Salvage Drum** is a metal or plastic open-head drum, tested to DOT requirements, used to transport damaged, defective, leaking or non-conforming hazardous materials packages, or hazardous materials that have spilled or leaked.



Tyvek Coveralls

- Keep out dust, particulates and moisture with these lightweight, durable coveralls
- Ideal for working around gasoline, electrical equipment, chemicals, paint, printing presses and even nuclear contaminants
- Effectively block asbestos, lead, radioactive dust and more
- Flexible and strong in wet or dry environments and in temperatures up to 100°F



A-TYVEK



A-APRON-WH

Endurosaf® Apron

- Get light protection from chemicals, oils and abrasion
- Composite fabric is better than neoprene, nitrile, or vinyl for use around food, chemicals and sensitive equipment
- Lightweight, 8-oz. construction offers all-day comfort
- Liquid-repellent finish makes cleaning simple

Dust Mask

- Economical and disposable
- Great for nuisance dusts such as animal dander, pollen or powders at exposures below OSHA limits



A-MASK



A-GOG

Safety Goggles

- Lightweight and comfortable design
- ANSI-compliant for impact protection
- Frame made from sturdy PVC plastic

Latex Boots

- Wear over work boots or shoes in spill response or around hazardous and toxic waste
- Disposable 0.70 mm gauge yellow latex rubber
- Easy on/off; non-skid sole



A-LATEXBOOTS

Spill Kit Accessory Items

Item #	Description	Size	Units/Pkg
A-TYVEK-L	Coveralls	L	1
A-TYVEK-XL	Coveralls	XL	1
A-APRON-WH	Apron - Enduro 2000™ Fabric	One Size Fits All	1
A-MASK	Dust Mask	One Size Fits All	1
A-GOG	Safety Goggles	One Size Fits All	1
A-LATEXBOOTS	Latex Boots	XL	1

Neoprene Gloves

- Fully-coated Neoprene Gloves won't fail when exposed to chemicals — even when completely submerged



A-GLV-NEO



A-GLV-NIT

Nitrile Gloves

- More chemical resistant than rubber gloves, with better puncture and abrasion resistance than PVC gloves

Epoxy Putty

- Versatile putty adheres to steel, glass, metals, masonry, wood and many plastics; sets in 20 minutes



A-EPOXY

Plug & Dike Epoxy



A-PND

- Non-toxic, non-flammable epoxy blend forms an immediate seal when applied
- Works with solvents, paints and water-based chemicals

Wooden Plugs

- Cover with a sorbent pad to plug a leak
- Wood and pad expand together to fill holes



A-WOODPLUGS



ANS1

Acid Neutralizing Sorbent

- Sorbent's visible color change tells you when absorbed acids have been neutralized and are safe to clean up

SuperSorbent Loose Sorbent

- Instantly soak up liquids to leave surfaces completely dry and reduce slip and fall injuries
- Super-concentrated formula absorbs 10 to 12 times more than clay
- 300% increased absorption capacity reduces cleanup time



SS1

Spill Kit Accessory Items

Item #	Description	Size	Units/Pkg	Absorbs/Pkg
A-GLV-NEO	Gloves - Neoprene	L	1	n/a
A-GLV-NIT	Gloves - Nitrile	One Size Fits All	1	n/a
A-GLV-NIT-CS	Gloves - Nitrile	One Size Fits All	144	n/a
A-EPOXY	Epoxy Putty	7" Stick	1	n/a
A-EPOXY-CS	Epoxy Putty	7" Stick	24	n/a
A-PND	Plug & Dike Epoxy	3.5" Dia., 2.5"H, 1 lb.	1	n/a
A-WOODPLUGS-SM	Wooden Plugs Small	Assorted .5" to .75"	9	n/a
A-WOODPLUGS-LG	Wooden Plugs Large	Assorted .5" to 1.75"	9	n/a
ANS1	Acid Neutralizing Sorbent	32 oz. Shaker	1	.2 gal.
SS1	SuperSorbent Loose Sorbent	28-oz. Shaker	1	.6 gal.

COMMANDER Mat

Repel water and absorb oily spills or overspray quickly.

- Naturally water-resistant, absorbs high volumes of oil — but not water — fast
- Low-profile sorbent can be used wherever you need to catch oil leaks, spills or overspray



WPF1014H

Wipers

Handle routine industrial cleaning with ease.

- Combines thickness, softness and absorbency for general cleanup duties
- Thick, high-loft construction with good wet strength and overall durability



WPR500-1

OverPack Cover

Protect spill response supplies indoors and out.

- Blocks water, dust and debris, as well as damaging UV light



A-COVER-LG

Light Stick

Just bend a Light Stick to activate hours of illumination for spill response in dark areas.

- Requires no batteries or electricity and contains no toxic chemicals

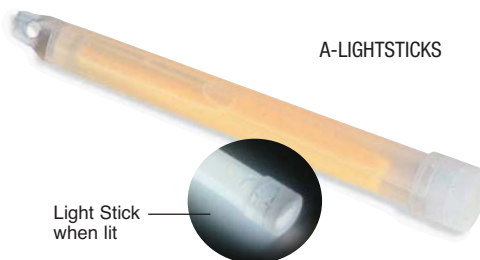

A-LIGHTSTICKS

Light Stick when lit

pH Tester Kit

Get instant pH checks over the entire range with general-purpose pH paper.

- Changes to 14 brilliant, distinct colors on one paper to cover the full pH range
- Kit includes color chart, dispenser and polyethylene case



A-PHTEST

Spill Kit Accessory Items

Item #	Description	Size	Units/Pkg	Absorbs/Pkg
WPF1014H	COMMANDER™/ Oil-Only HeavyWeight Pads	10" x 14"	100	18.1 gal.
GPF1014H	COMMANDER™/ Universal HeavyWeight Pads	10" x 14"	100	18.1 gal.
YPF1014H	COMMANDER™/ HazMat HeavyWeight Pads	10" x 14"	100	18.1 gal.
WPR500-1	Series 350 Airlaid Wipers	11.5" x 13"	25	n/a
A-COVER-SM	OverPack Cover	for 20- & 30-gal. OverPacks	1	n/a
A-COVER-LG	OverPack Cover	for 65- & 95-gal. OverPacks	1	n/a
A-PHTEST	pH Tester Kit	50'L Tape	1	n/a
A-LIGHTSTICKS	Light Stick	6"L	1	n/a

Emergency Response GuideBook

Identify hazards in all types of accidents or spills.

- A great source of information for responding quickly to spills of all types
- Color-coded and indexed so it's easy to find information
- Updated every four years

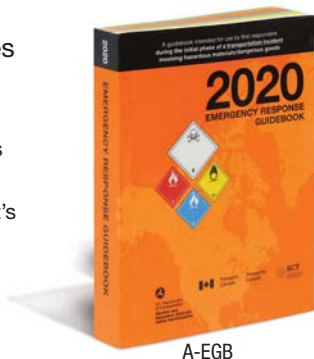

A-EGB

Temporary Disposal Bag

Ideal for 55-gallon drums.

- Printed with "Caution Handle with Care"
- 3-mil thick to resist punctures
- Also available in roll of 125 bags (A-DISPAG-ROLL)



Spill Kit Label

Label your spill kit to make it easier to find.

- Eye-catching yellow "Spill Kit" text on black background stands out on container
- Durable, 4 mil vinyl with acrylic adhesive is moisture-resistant and suitable for outdoor use
- Non-glare surface is easier to read



Tamper-Proof Seal

Discourage tampering and remember to restock using adhesive labels.

- If workers open a sealed kit, this label breaks, alerting you that the kit has been opened and may no longer contain a full supply of absorbents

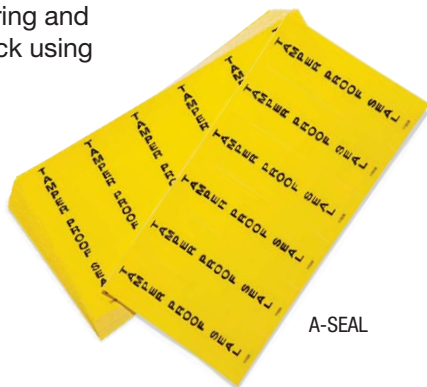

A-SEAL

Non-Sparking Shovel

Prevent sparking with anti-static shovel.

- Collapsible Non-Sparking Shovel is specifically designed for spill kits and industrial cleanup applications
- Constructed of rugged polypropylene for chemical resistance; will not rust or corrode



A-SHOVNS

HazWaste Label

Mark your hazardous materials with durable adhesive label.

- Label reads "Hazardous Waste"
- Size is 6" x 6"
- Include ample space to include information necessary to mark a container for transport in compliance with EPA regulations



A-WASTE

Spill Kit Accessory Items

Item #	Description	Size	Units/Pkg
A-EGB	Emergency Response GuideBook	384 Pages 4"W x 5.5"H	1
A-SEAL	TamperProof Seals	2"W x 6"L	6
A-WASTE	Hazardous Waste	6"W x 6"L	1
A-DISPAG	Temporary Disposal Bag	30"L x 6"D x 60"H	1
A-DISPAG-ROLL	Temporary Disposal Bags	30"L x 6"D x 60"H	125
A-DISPAG-SM	Temporary Disposal Bag	18"L x 6"D x 30"H	1
NEW A-KITLABEL	Spill Kit Label	3"W x 5"L	1
A-SHOVNS	Non-Sparking Shovel	Blade: 10.5"W x 14"H Overall: 43.5"H	1



Roof and Pipe Leak Diverters

Keep fluid leaks off the floor while eliminating slip hazards and chemical exposure.

- Large openings capture pipe and roof leaks and channel them away from plant personnel, offices and machinery
- **LDHOSE** allows you to monitor liquid flow and blend into industrial environments
- **LDSTRAPS** help you hang your leak diverter almost anywhere

Roof and Pipe Leak Diverters

Item #	Description	Size	Units/Pkg
LD1818	Pipe Leak Diverter	18"L x 18"W	1
LD55	Roof Leak Diverter	5'L x 5'W	1
LD1010	Roof Leak Diverter	10'L x 10'W	1
LDHOSE	Clear Drainage Hose	25'L	1
LDSTRAPS	Rubber Hanging Straps	19"L	4



Installation is easy – simply hang from overhead pipes.

SpillBerm Plus Containment Barrier

Non-absorbent polyurethane deploys fast to prevent spills and leaks from spreading or contaminating drains.

- Sturdy, flexible 100% polyurethane barrier stands up to oils, coolants, solvents and water
- Tacky bottom grips smooth surfaces and keeps liquids from seeping underneath
- Built-in dovetail connectors create a leakproof seal and let you combine lengths of SpillBerm to fit any area — without extra parts

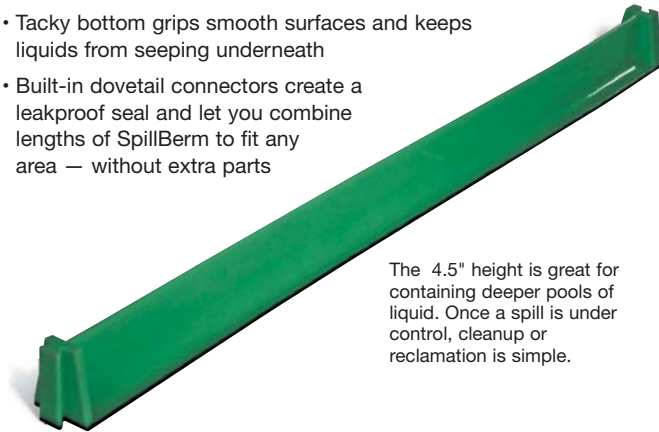

The 4.5" height is great for containing deeper pools of liquid. Once a spill is under control, cleanup or reclamation is simple.

SpillBerm Plus Containment Barrier

Item #	Description	Size	Units/Pkg
PBL253	SpillBerm Plus	5'L x 4"W x 4.5"H	1

HYC

Helps you comply with 40 CFR 112.7(c)(1) and 40 CFR 263.30(a). See page 123 for details.

Connectable Spill Berm

A tacky bottom helps create a tight seal to confine leaks around machines or guard drains.

- Easily bends to fit any angle or curve
- Quick-connect interlocking ends “snap” individual sections together to create longer lengths, so you can contain almost any spill
- Flexible 100% polyurethane elastomer is non-absorbent and resistant to a wide variety of chemicals and fluids
- Just clean it with soap and water, then it's ready to reuse

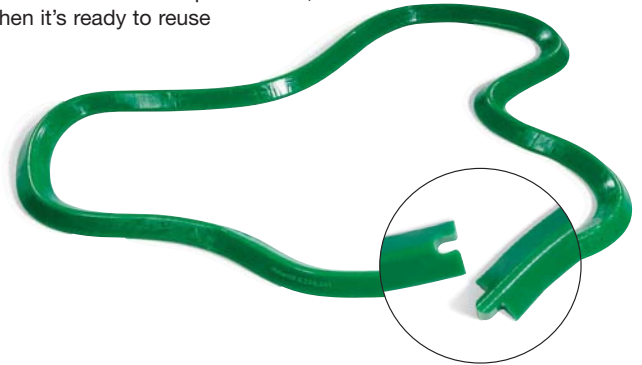

Connectable Spill Berm

Item #	Description	Size	Units/Pkg
SPB10C	Connectable Spill Berm	10'L x 2.25"W x 1.375"H	1

HYC

Helps you comply with 40 CFR 112.7(c)(1) and 40 CFR 263.30(a). See page 123 for details.

SpillCurb Containment Berm

Divert or contain liquids without absorbing them using a customizable polyurethane SpillCurb Containment Berm.

- Sturdy, flexible 100% polyurethane berm stands up to oils, coolants, solvents and water
- Combine 10' lengths of SpillCurb with Corners and Connectors to fit any area
- Tacky bottom grips smooth surfaces
- Store near spill-prone areas since it's quick and easy to deploy
- Cleans easily with soap and water for reuse

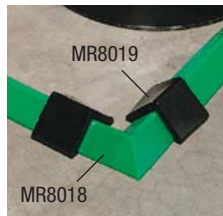

SpillCurb Containment Berm

Item #	Description	Size	Units/Pkg
MR8014	SpillCurb	10'L x 3.75"W x 2.25"H	1
MR8018	SpillCurb Corner	4"L x 3.75"W x 2.25"H	1
MR8019	SpillCurb Connector	4"L x 2.25"H	1

HYC

Helps you comply with 40 CFR 112.7(c)(1) and 40 CFR 263.30(a). See page 123 for details.

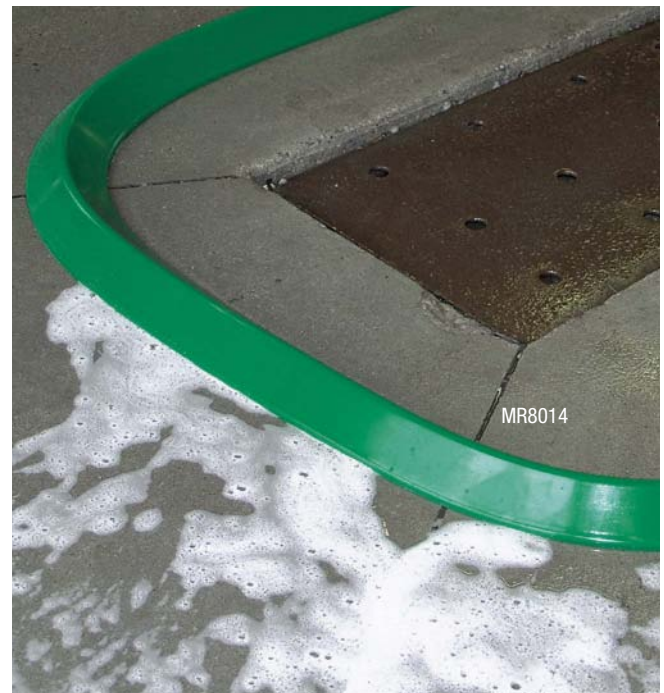



ADC42-R



ADC36-CASE

Your DrainCover fits inside this optional hi-viz case to protect it from weather, abrasion, puncture, UV and more, so it's ready to use when you need it.

DrainCovers

Tough, reversible drain covers in three sizes.

- Solid polyurethane covers are tacky on both sides so either can form a tight seal to block contaminants
- More chemical resistant than rubbers or plastics, covers stand up to a wide range of chemicals, solvents and oils
- Reusable; can be washed then stored in the handy, portable box
- Transport and store your drain covers in optional polypropylene cases to better protect them from damage

DrainCovers

Item #	Description	Size	Units/Pkg
ADC12-CIR	12" DrainCover	12"Dia. x .25"H	1
ADC36-R	36" DrainCover	36"L x 36"W x .25"H	1
ADC36-CASE	Case for 36" Cover	7.25"Dia. x 38"L	1
ADC42-R	42" DrainCover	42"L x 42"W x .25"H	1
ADC42-CASE	Case for 42" Cover	7.25"Dia. x 50"L	1
ADC48-R	48" DrainCover	48" x 48"W x .25"H	1

HYC

Helps you comply with 40 CFR 112.7(c)(1) and 40 CFR 263.30(a). See page 123 for details.

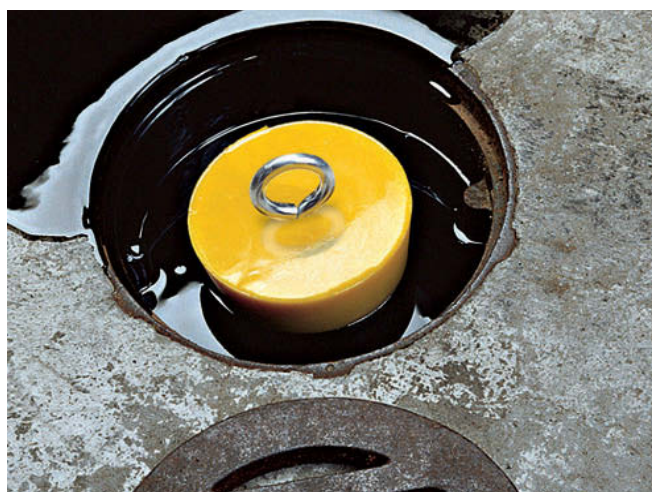

A Conical DrainPlug fits discreetly under the grate to prevent spilled oil and other pollutants from getting into your drains without disrupting traffic or creating a trip hazard.

Conical DrainPlugs

Confidently block pollution without a permanent seal.

- Reusable Conical DrainPlug fits conveniently under a drain's grate and pulls out easily to allow normal flow
- Chemical-resistant polyurethane reliably seals drain to keep out unwanted liquids
- Easy to install — just lift grate, press tapered Conical Plug into drain and replace grate; to remove, pull up on metal ring using hand tools
- Cleans easily with soap and water for reuse

Conical DrainPlugs

Item #	Description	Size	Units/Pkg
DP2	2" Dia. DrainPlug	2"Dia. x 4.75"H	1
DP3	3" Dia. DrainPlug	3"Dia. x 5"H	1
DP4	4" Dia. DrainPlug	4"Dia. x 5.75"H	1
DP6	6" Dia. DrainPlug	6"Dia. x 5.5"H	1

HYC

Helps you comply with 40 CFR 112.7(c)(1) and 40 CFR 263.30(a). See page 123 for details.



DP2

DP3

DP4

DP6



Ultra-Dewatering Bag

Contain sediment and oil during dewatering operations.

- Captures both sediment and oil, offering a combination of benefits not available in alternative dewatering bags
- Can be used as a Best Management Practice in a Stormwater Pollution Prevention Plan



Ultra-Dewatering Bag accepts up to a 4" discharge hose for high-volume pumpouts of sumps, lagoons, ponds and more.

Ultra-Dewatering Bag®

Item #	Description	Size	Units/Pkg
ULT9729-OS	Ultra-Dewatering Bag®	3'L x 4'W	1
ULT9724-OS	Ultra-Dewatering Bag®	6'L x 6'W	1
ULT9725-OS	Ultra-Dewatering Bag®	10'L x 15'W	1



Ultra-GutterGuard

Prevent pollutants and debris from entering curb inlets.

- Multi-dimensional outer filter combined with rigid inner frame maintains a low profile to prevent damage from vehicular traffic
- Allow 12" overlap on each side of gutter

Ultra-GutterGuard®

Item #	Description	Size	Units/Pkg
† ULT9320	Ultra-GutterGuard®	9" Dia. x 8'L	1
† ULT9321	Ultra-GutterGuard®	9" Dia. x 10'L	1
† ULT9322	Ultra-GutterGuard®	9" Dia. x 12'L	1

† These items drop ship from vendor

HYC

Helps you comply with 40 CFR 122.26. See page 123 for details.



Ultra-DrainGuard

Removes waste from stormwater before it's a problem.

- Removes up to 0.87 gallons of hydrocarbons as well as dirt, sand and other contaminants
- Designed for use in industrial facilities, construction sites, retail facilities and parking lots

Ultra-DrainGuard®

Item #	Description	Size	Units/Pkg
ULT9217	Ultra-DrainGuard® Oil & Sediment Filter	48"L x 36"W x 18"H	1
ULT9218	Ultra-DrainGuard® Oil & Sediment Filter	48"L x 36"W x 18"H	10

HYC

Helps you comply with 40 CFR 122.26. See page 123 for details.



CONTAINMENT

Manage your liquids safely and securely both in your facility and on the road.

Liquids don't always stay where they belong. Protect your drains and the environment with SpillTech containment products. We've got solutions to keep you safe and compliant throughout your workplace or on the road.



Outdoor Containment - 90-92



Containment Berms - 96-97



Portable Containment - 98-99





Create Custom Drum Storage with Ultra-Spill Decks

Low-profile, modular Spill Decks let you design and create a containment system that meets your specific needs.

- 1-, 2- and 4-Drum Ultra-Spill Decks can be used alone or are easily connected together with Bulkhead Fittings (**BHFIT**) and T-Strips (**T-STRIP**) to allow a virtually unlimited number of customized configurations
- Bulkhead Fittings lock Spill Decks together while allowing spills to flow between decks; can help you meet containment regulations depending on the size of container stored and the total sump capacity of the deck system
- All-polyethylene construction meets a wide range of chemical compatibility needs
- Low height offers safe and convenient loading/unloading of drums
- Optional Loading Ramp (**DECKRAMP**) provides added drum handling safety and convenience

Ultra-Spill Decks®

Item #	Description	Size	Load Cap.	Sump Cap.
DECK1	1-Drum Section	26"L x 26"W x 5.75"H	3,000 lbs.	11.0 gal.
DECK2	2-Drum Section	52"L x 26"W x 5.75"H	3,000 lbs.	22.0 gal.
DECK4	4-Drum Section	52"L x 52"W x 5.75"H	6,000 lbs.	44.0 gal.
BHFIT	Bulkhead Fitting	.75" Dia.	n/a	n/a
DECKRAMP	Loading Ramp	24"L x 32"W x 5.75"H	n/a	n/a
T-STRIP	T-Strips	26"	n/a	n/a

Smart Selection Tip:

Assembly is fast and easy!



1 First, drill holes for the Bulkhead Fittings (sold separately).



2 Next, connect the decks with the Bulkhead Fittings.



3 Insert T-Strips (sold separately) between deck sections and you're done!



1-Drum Bladder System

Hidden containment bladder automatically unfurls to capture large spills or drum leaks.

- Low-profile, single-drum containment unit helps you meet EPA and UFC Containment Regulations
- Compact footprint saves valuable floor space; perfect for single-drum waste collection
- Protective trap door opens automatically to allow bladder to unfurl and fill up in the event of large leaks and spills

Ultra-Spill Deck P1 Bladder System®

Item #	Description	Size	Load Cap.	Sump Cap.
--------	-------------	------	-----------	-----------

† BLADDER1 1-Drum Bladder System 26"L x 30.5"W x 5.75"H 1,500 lbs. 66.0 gal.

† These items drop ship from vendor

IBC Spill Pallets

Economical and portable containment for IBCs.

- 1-IBC Pallets feature low height and small footprint
- 2-IBC Pallets have a continuous, high-capacity sump
- All-polyethylene for chemical resistance
- Five inner support columns easily hold a fully loaded IBC



IBC-ND

IBC Spill Pallets

Item #	Description	Size	Load Cap.	Sump Cap.
† IBCTWIN-ND	2-IBC w/o Drain	124.5"L x 61.625"W x 22"H	8,000 lbs. per side	535.0 gal.
† IBCTWIN-WD	2-IBC w/ Drain	124.5"L x 61.625"W x 22"H	8,000 lbs. per side	535.0 gal.
IBC-ND	1-IBC w/o Drain	62"L x 62"W x 28"H	8,500 lbs.	360.0 gal.
IBC-WD	1-IBC w/ Drain	62"L x 62"W x 28"H	8,500 lbs.	360.0 gal.
IBCSHELF	Bucket Shelf	19.5"L x 16"W x 14.5"H	n/a	3.0 gal.

† These items drop ship from vendor

Ultra-SpillPallets/Economy Model



PALLET4-WD

Store drums and spill-prone containers to help you comply with regulations.

- Low profile and heavy load capacity; 4-drum pallets hold up to 3,000 pounds, 2-drum pallets up to 1,500
- 66-gallon sump to keep you in compliance in the event of a small leak or complete drum failure
- Lightweight polyethylene construction is resistant to chemicals



SpillTech



PALLET2-WD

Ultra-SpillPallets® / Economy Model

Item #	Description	Size	Load Cap.	Sump Cap.
PALLET2-WD	2-Drum w/ Drain	53"L x 29"W x 16.5"H	1,500 lbs.	66.0 gal.
PALLET2-ND	2-Drum w/o Drain	53"L x 29"W x 16.5"H	1,500 lbs.	66.0 gal.
PALLET4-WD	4-Drum w/ Drain	53"L x 53"W x 11.75"H	3,000 lbs.	66.0 gal.
PALLET4-ND	4-Drum w/o Drain	53"L x 53"W x 11.75"H	3,000 lbs.	66.0 gal.
† PALLETRAMP	Loading Ramp	68.5"L x 28.5"W x 12"H	N/A	N/A

† These items drop ship from vendor

HYC

Helps you comply with 40 CFR 264.175. See page 123 for details.



A lightweight poly ramp lets you load units using a drum truck. Stores inside when not in use.

Ultra-Hard Top Plus for Drums

Store hazardous drums outdoors with pumps and funnels in place.

- Extra headspace easily accommodates rotary drum pumps and large conical funnels
- Low-profile pallet positions drum tops at a safe level to pour wastes into funnels
- 100% polyethylene construction will not rust or corrode

Ultra-Hard Top Plus® / Drums

Item #	Description	Size	Load Cap.	Sump Cap.
† HARDTOP4-WD	4-Drum with Drain	64.5"L x 62"W x 79"H	9,000 lbs.	75.0 gal.
† NEW HARDTOP4-ND	4-Drum no Drain	64.5"L x 62"W x 79"H	9,000 lbs.	75.0 gal.
† HARDTOP2-WD	2-Drum with Drain	67.25"L x 41.25"W x 74"H	4,500 lbs.	66.0 gal.
† NEW HARDTOP2-ND	2-Drum no Drain	67.25"L x 41.25"W x 74"H	4,500 lbs.	4,500 lbs.
† HTRAMP	Hard Top Loading Ramp	55.5"L x 28.5"W x 8.75"H	n/a	n/a

† These Items drop ship from vendor

IBC Roll Tops

Comply with regs while storing IBC tanks outdoors.

- Upper roll-top cover and swing out lower doors combine to allow easy and convenient access to IBC
- Low-profile containment pallet allows safe material handling and dispensing
- Forkliftable, lockable, all-polyethylene design will not rust or corrode

IBC Roll Tops

Item #	Description	Size	Load Cap.	Sump Cap.
† NEW IBCHT-WD	IBC Hard Top with Drain	62" W x 64.5" L x 96" H	525 lbs.	360 gal.
† NEW IBCHT-ND	IBC Hard Top no Drain	62" W x 64.5" L x 96" H	525 lbs.	360 gal.

† These Items drop ship from vendor

HYC Helps you comply with 40 CFR 264.175 . See page 123 for details.



IBCHT-WD

Poly-Rack Drum Storage System

Create a storage system for up to six drums.

- The centerpiece of the Poly-Rack System is the Poly Racker (**ENP6000**), a unique one-piece polyethylene rack that secures two 55-gallon drums
- Add up to two Poly Stackers (**ENP6002**) to your Poly Racker to increase drum storage; holds two 55-gallon drums and can be quickly stacked with a forklift
- Increase safety and productivity when you add the Poly Shelf (**ENP6003**) to your Poly-Rack System



Poly-Rack Drum Storage System

Item #	Description	Size	Load Cap.	Sump Cap.
† ENP6000	Poly Racker	49"L x 23"W x 53"H	3000 lbs.	103.0 gal.
† ENP6002	Poly Stacker	49"L x 41"W x 13"H	2400 lbs.	n/a
† ENP6003	Poly Shelf	17"L x 22"W x 17.5"H	60 lbs.	n/a

† These items drop ship from vendor

Poly-Dolly Portable Dispensing Station

A dolly, dispensing rack and containment sump — all in one.

- Safe and easy way to transport and dispense from 55-gallon drums
- Built-in 80-gallon sump

Poly-Dolly® Portable Dispensing Station

Item #	Description	Size	Load Cap.	Sump Cap.
ENP5300	Poly-Dolly®	69"L x 32.5"W x 26.5"H	600 lbs.	80.0 gal.



HYC

Helps you comply with 40 CFR 264.175 . See page 123 for details.

Containment Sumps

Sump offers secondary containment for oval tanks.

- Eliminate costly spills while storing fuels, oils and other hazardous liquids
- 100% polyethylene construction will not rust or corrode
- Provides superior chemical and weather resistance
- Offers best protection for non-monitored containment sites

Ultra Containment Sump®

Item #	Description	Size	Sump Cap.
† SUMP275-WD	275 Sump with Drain	84.5"L x 43.75"W x 29"H	360.0 gal.
† NEW SUMP275-ND	275 Sump no Drain	84.5"L x 43.75"W x 29"H	360.0 gal.
† SUMP550-WD	550 Sump with Drain	87"L x 62.25"W x 32.75"H	605.0 gal.
† NEW SUMP550-ND	550 Sump no Drain	87"L x 62.25"W x 32.75"H	605.0 gal.

† These items drop ship from vendor



Poly-Collector and Accessories



Funnel completely covers your large-diameter drum for clean draining and pouring.

- Entire drum top is covered to minimize drips and spills
- Allows access to 3/4" bung for the use of a liquid-level gauge
- Zigzag ridges inside of funnel help to prevent splashes and catch tools or parts

Poly-Collector is the economical choice for containment of 55-gallon drums.

- Strong, tough, 100% polyurethane outer shell has a 66-gallon capacity — holds a 55-gallon drum, even if ruptured or leaking
- UV-stabilized for a long, productive work life

Dolly mobilizes your Poly-Collector for convenient point-of-use dispensing or collection.

- Castored wheels support the Poly-Collector even when it's fully loaded; easy movement for dispensing and emptying

Funnel/Poly-Collector™/Dolly

Item #	Description	Size	Units/Pkg
NEW FNL100	Universal Poly-Drum Funnel	23.6" Dia. x 5.5"H	1
† ENP8075	Poly-Collector™	32.5" Dia. x 31"H	1
† ENP8050	Drum Dolly	27.5" Dia. x 5.5"H	1

† These items drop ship from vendor

Ultra-Burp-Free Funnels

No more splashing or “burping” when pouring liquids.

- Threaded brass insert screws into 2" drum bung
- All-polyethylene construction won't rust or corrode; provides excellent chemical resistance
- Hinged, lockable lid prevents unauthorized access



FUNNEL-S

Eliminating “burps” means you can pour flammables or chemicals faster and more safely.

Ultra-Burp-Free Funnel®

Item #	Description	Size	Units/Pkg	Weight/Pkg
FUNNEL-S	Ultra-Burp-Free Funnel	13.375" Dia. x 11"H	1	6 lbs.
FUNNEL-L	Ultra-Burp-Free Funnel	22" Dia. x 11.5"H	1	8 lbs.

Poly-Edge

Perfect for storing your Prowler Pool, Spill Kit or any other supplies.

- Can be used as a truck-mounted spill response unit or mounted to a wall where it doubles as a 20-gallon sump
- Lockable large-capacity unit offers versatile storage for tools, absorbents and other equipment
- Special weather- and water-resistant gasket keeps stored items dry



Poly-Edge®

Item #	Description	Size	Sump Cap.
† ENP1601	Poly-Edge®	34.75" L x 20" W x 15" H	20.0 gal.

† These items drop ship from vendor

See our Prowler Pools - Page 98



Utility Trays

Help keep messy drips and spills off warehouse and factory floors.

- Heavy-duty polyethylene construction will not rust or corrode
- Ribbed bottom keeps cans, pails and other containers elevated above small spills or leaks
- Nestable for easy storage when not in use

NEW



TRAY2436

Utility Trays

Item #	Description	Size	Sump Cap.
NEW TRAY1248	Poly Utility Tray	48" W x 12" L x 4.75" H	12 gal.
NEW TRAY2436	Poly Utility Tray	36" W x 24" L x 4.75" H	18 gal.
NEW TRAY2448	Poly Utility Tray	48" W x 24" L x 4.75" H	24 gal.
NEW TRAY3048	Poly Utility Tray	48" W x 30" L x 4.75" H	30 gal.
NEW TRAY3636	Poly Utility Tray	36" W x 36" L x 4.75" H	27 gal.
NEW TRAY4048	Poly Utility Tray	48" W x 40" L x 3.5" H	30 gal.

HYC

Helps you comply with 40 CFR 264.175, 40 CFR 122.26 and 40 CFR 112.7. See page 123 for details.



**Create
Custom
Containment!**



BUILD YOUR OWN BERM

Build your own custom-size barrier around equipment, indoors or out.

- Semi-permanent, highly visible berm that's customizable to your desired size and shape
- Vinyl-covered foam barrier resists oils, coolants and most chemicals
- Contains liquids around leaky machinery or storage areas
- Easy to cut with utility knife
- Recovers its shape under foot traffic or light, wheeled equipment
- Create any drive-over containment configuration by combining components; ends overlap and can be sealed together for liquid-proof containment

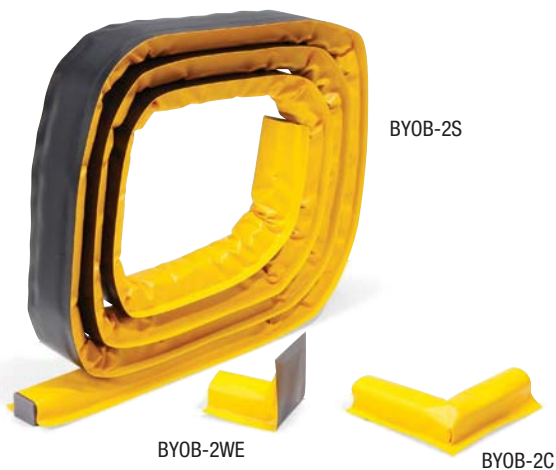

Build Your Own Berm

Build your own barrier around equipment or storage.

- Corners, wall ends and straight sections secure tightly for leak-free connections
- Easy to install, and remove simply with a flat-bladed shovel
- Open-cell foam interior springs back into shape after you walk on it or roll over it with a hand cart.
- BYOB-KIT includes four straight sections, four corners and Sili-Thane sealant to create a customized shape

Drive-Over Build Your Own Berm

Contain and control liquid in high-traffic areas.

- Customizable containment barriers pop right back to form after vehicles, pallet jacks or dollies roll over them.
- Berm compresses to approximately 1/4" when driven over; constructed of 40-ounce, vinyl-coated fabric with an open-cell foam core
- 2" height accommodates low-clearance traffic

Build Your Own Berm

Item #	Description	Size	Units/Pkg
BYOB-KIT	BYOB Kit	60'L x 5.5"W x 2"H Kit	1
BYOB-2S	BYOB Straight Section	15'L x 5.5"W x 2"H	1
BYOB-2C	BYOB Corners	7.25"L x 5.5"W x 2"H	2
BYOB-2WE	BYOB Wall Ends	3"L x 5.5"W x 2"H	2

Drive-Over Build Your Own Berm

Item #	Description	Size	Units/Pkg
DOBYOB-2S	DOBYOB Straight Section	12'L x 5.5"W x 2"H	1
DOBYOB-2VC	DOBYOB Vented Corners	11.25"L x 5.5"W x 2"H	2
DOBYOB-2WE	DOBYOB Wall Ends	3"L x 5.5"W x 2"H	2

INSTALLATION ACCESSORIES TO BUILD YOUR BUILD YOUR OWN BERM.

- Use vinyl cement (BYOB-CEMENT) to connect Build Your Own Berm sections at seams
- Use sealant (BYOB-SEAL) to secure your Barriers to the floor; forms a one-part hybrid seal that is flexible and liquidtight.

BYOB-SEAL



BYOB-CEMENT

Build Your Own Berm Installation Tools

Item #	Description	Size	Units/Pkg
BYOB-SEAL	Sili-Thane Sealant	2" x 11.25"H	6
BYOB-CEMENT	BYOB Cement	8 oz.	1

Smart Selection Tip:

SIMPLE INSTALLATION

1. Cut to desired length with scissors or utility knife
2. Fit pieces together and secure to floor with silicone sealant
3. Seal seams with industrial-strength vinyl cement
4. Drive-Over version only: Reinforce with predrilled aluminum mounting strips that secure berm to most surfaces





Step 1: Remove and open Prowler Pool.



Step 2: Position pool underneath spill source.



Step 3: Pool contains up to 150 gallons of liquid.

Prowler Spill Containment Pools

Ideal for containing spills when you're on the road or anywhere you spring a leak.

- This lightweight, portable pool quickly unfolds to become a self-supporting containment unit; excellent for immediate spill response
- Superior resistance to many chemicals for long life



Prowler™ Pop-Up Spill Containment Pools

Item #	Description	Size	Capacity
ENP5920	Prowler™ Pool	28"base x 13"H x 18"opening	20.0 gal.
ENP5966	Prowler™ Pool	48"base x 14"H x 36"opening	66.0 gal.
ENP5900	Prowler™ Pool	48"base x 18"H x 32"opening	100.0 gal.
† ENP5950	Prowler™ Pool	60"base x 18"H x 44"opening	150.0 gal.

† This Item will drop ship from vendor

HYC

Helps you comply with 40 CFR 263.30(a). See page 123 for details.

SpillPal Portable Spill Containment

Flexible sidewalls provide quick, portable spill containment.

- Great alternative to hard poly pallets that must be moved with a forklift
- Provides versatile, portable spill control during temporary storage of drums, machine parts, tanks and generators

SpillPal™ Portable Spill Containment

Item #	Description	Size	Sump Cap.
SPAL1	1-Drum SpillPal™	2'L x 2'W x 3"H	7.5 gal.
SPAL2	2-Drum SpillPal™	2'L x 4'W x 3"H	15.0 gal.
SPAL4	4-Drum SpillPal™	4'L x 4'W x 3"H	30.0 gal.



Foam sidewalls allow easy access for driveovers from handtrucks and forklifts.

Duck Pond

Perfect when storage space is limited.

- Reusable Duck Pond provides affordable, reliable secondary containment for oils and other liquids
- Built to withstand extreme cold to -55°F/-48°C
- Easy to handle for quick response in small areas
- Great for leaking machines, preventative maintenance, drips and as a low-sidewall pop-up pool alternative
- Bright green color for high visibility
- Complies with EPA, SPCC and NPDES regulations

Duck Pond Secondary Containment

Item #	Description	Size	Sump Cap.
DKP2X2	Duck Pond	2'L x 2'W x 4"H	10.0 gal.
DKP2X3	Duck Pond	2'L x 3'W x 4"H	15.0 gal.
DKP4X4	Duck Pond	4'L x 4'W x 4"H	40.0 gal.
DKP4X6	Duck Pond	4'L x 6'W x 4"H	60.0 gal.



Folding Duck Pond

Higher sidewalls and easier-to-fold design.

- Reusable Folding Duck Pond provides reliable secondary containment for oils and other liquids
- Thinner 2"-wide sidewall has straps to secure the folded pond for compact storage; fits easily in a cabinet or on a shelf
- Extended 6" sidewall creates 30% additional spill capacity
- Built to withstand extreme cold to -55°F/-48°C
- Great for leaking machines, preventative maintenance, drips and as a low-sidewall pop-up pool alternative
- Bright green color for high visibility
- Complies with EPA, SPCC and NPDES regulations

Folding Duck Pond

Item #	Description	Size	Sump Cap.
FDKP2X3	Folding Duck Pond	2'L x 3'W x 6"H	22.0 gal.
FDKP2X4	Folding Duck Pond	2'L x 4'W x 6"H	30.0 gal.
FDKP4X6	Folding Duck Pond	4'L x 6'W x 6"H	74.0 gal.

Drive Your Truck Right In!



PAC1250

CONTAINMENT BERMS AND ACCESSORIES

Ideal for large-scale spill containment beneath tanker trucks, roll-off containers and more.

- Portable design permits immediate response, compact storage and transport
- Fold down the sidewalls and drive right in for instant containment
- Simply clean and store after use
- Excellent rip, tear and puncture resistance for demanding applications and rough terrain
- Compatible with acids, water, oils and solvents
- Berm is repairable and portable
- Constructed of chemical-resistant materials; durable and sturdy
- 3/4" - 2" drain plug options available
- Customization available

HYC

Helps you comply with 40 CFR 263.30(a) and 40 CFR 264.175). See pages 123 for details.

GROUND COVERS, TRACK GUARDS AND REPAIR TAPE

- **GC1212-1250**
Reusable ground cover protects berms from sharp objects or rough terrain
- **TG3612-3650**
Placed inside the berm, track guards protect berm from punctures and tears from truck traffic



TG3650

Accessories

Item #	Description	Size	Sump Cap.
GC1212	Ground Cover for 12' x 12'	12'L x 12'W	n/a
GC1225	Ground Cover for 12' x 25'	12'L x 25'W	n/a
GC1250	Ground Cover for 12' x 50'	12'L x 50'W	n/a
TG3612	2 - Track Guards for 12' x 12'	36"L x 12'W	n/a
TG3625	2 - Track Guards for 12' x 25'	36"L x 25'W	n/a
TG3650	2 - Track Guards for 12' x 50'	36"L x 50'W	n/a
BERM-TAPE	Containment Berm Repair Tape	4" x 50'	n/a

Choose From Four Containment Berm Styles:

Basic Containment Berm with L Bracket

- 40-mil LLDPE construction is lightweight for easy handling, storage and transportation
- Sidewalls are supported by sturdy L-shaped composite brackets



Basic Containment Berm with L Bracket

Item #	Description	Size	Sump Cap.
BERM68E	Containment Berm - L Bracket	8'L x 6'W x 1'H	359 gal.
BERM1212E	Containment Berm - L Bracket	12'L x 12'W x 1'H	1,077 gal.
† BERM1250E	Containment Berm - L Bracket	12'L x 50'W x 1'H	4,488 gal.

† This item will drop ship from vendor

Premium Containment Berm with L Bracket

- Reinforced Coolguard® fabric resists rips, tears and punctures; highly durable for demanding applications
- Sidewalls are supported by sturdy L-shaped composite brackets



Premium Containment Berm with L Bracket

Item #	Description	Size	Sump Cap.
BERM48L	Containment Berm - L Bracket	8'L x 4'W x 1'H	239 gal.
BERM88L	Containment Berm - L Bracket	8'L x 8'W x 1'H	478 gal.
BERM1212L	Containment Berm - L Bracket	12'L x 12'W x 1'H	1,077 gal.
BERM1225L	Containment Berm - L Bracket	12'L x 25'W x 1'H	2,244 gal.
BERM1250L	Containment Berm - L Bracket	12'L x 50'W x 1'H	4,488 gal.

Containment Berm - Foam Wall

- Soft foam sidewalls allow you to roll in equipment or vehicles with minimal set up
- Low profile 4" walls compress under equipment then bounce back into shape
- Use for frac tanks, vehicle washdown, refueling areas and secondary containment areas



Containment Berm - Foam Wall

Item #	Description	Size	Sump Cap.
† BERM68FE	Containment Berm - Foam Wall - Economy	6'L x 8'W x 4"H	120 gal.
† BERM1212FE	Containment Berm - Foam Wall - Economy	12'L x 12'W x 4"H	359 gal.
† BERM1212FC	Containment Berm - Foam Wall - Coolguard®	12'L x 12'W x 4"H	359 gal.
† BERM1225FE	Containment Berm - Foam Wall - Economy	12'L x 25'W x 4"H	748 gal.
† BERM1225FC	Containment Berm - Foam Wall - Coolguard®	12'L x 25'W x 4"H	748 gal.
† BERM1250FE	Containment Berm - Foam Wall - Economy	12'L x 50'W x 4"H	1,496 gal.
† BERM1250FC	Containment Berm - Foam Wall - Coolguard®	12'L x 50'W x 4"H	1,496 gal.

† These items drop ship from vendor

Instaberm Containment Berm

- One-piece design permits immediate response, compact storage and transport; just fold down the sidewalls and drive right in for instant containment



Instaberm Containment Berm

Item #	Description	Size	Sump Cap.
† PAC1212	Containment Berm	12'L x 12'W x 1'H	1,077 gal.
† PAC1225	Containment Berm	25'L x 12'W x 1'H	2,244 gal.
† PAC1250	Containment Berm	50'L x 12'W x 1'H	4,488 gal.

† These items drop ship from vendor

A-Aggressive

S-Solvents

O-Oil

W-water

Compatibility:

Complete Product SpecSheet

Universal CONTRACTOR GRADE Mat Pads		Gray Universal (for oils, coolants, solvents & water)						Pages 6-7
Item #	Description	Size	Units/Package	Absorbs/Pkg. (gal.)	Qty./Pallet	Compatibility	Incinerable?	Page #
GP-H	HeavyWeight Pads	15" x 18"	100	22.0 gal.	42	W, O, S	yes	6-7
GP-M	MediumWeight Pads	15" x 18"	100	20.0 gal.	48	W, O, S	yes	6-7
GP-S	LightWeight Pads	15" x 18"	200	35.0 gal.	30	W, O, S	yes	6-7

Universal CONTRACTOR GRADE Mat Rolls		Gray Universal (for oils, coolants, solvents & water)						Pages 6-7
Item #	Description	Size	Units/Package	Absorbs/Pkg. (gal.)	Qty./Pallet	Compatibility	Incinerable?	Page #
GR-H	HeavyWeight Roll	30" x 150'	1	44.0 gal.	21	W, O, S	yes	6-7
GR-M	MediumWeight Roll	30" x 150'	1	40.0 gal.	21	W, O, S	yes	6-7

Universal DEFENDER™ Mat Pads		Gray Universal (for oils, coolants, solvents & water)						Pages 8-9
Item #	Description	Size	Units/Package	Absorbs/Pkg. (gal.)	Qty./Pallet	Compatibility	Incinerable?	Page #
GPB100H	HeavyWeight Pads	15" x 19"	100	29.1 gal.	30	W, O, S	yes	8-9
GPB50H	HeavyWeight Pads	15" x 19"	50	14.6 gal.	48	W, O, S	yes	8-9
GPKB50H	HeavyWeight King Pads	30" x 30"	50	45.3 gal.	15	W, O, S	yes	8-9
GPB100M	MediumWeight Pads	15" x 19"	100	24.7 gal.	36	W, O, S	yes	8-9
NEW GPB50M	MediumWeight Pads	15" x 19"	50	12.35 gal.	48	W, O, S	yes	8-9
GPB200S	LightWeight Pads	15" x 19"	200	31.1 gal.	30	W, O, S	yes	8-9
GPB100S	LightWeight Pads	15" x 19"	100	15.6 gal.	48	W, O, S	yes	8-9

Universal DEFENDER™ Mat Rolls		Gray Universal (for oils, coolants, solvents & water)						Pages 8-9
Item #	Description	Size	Units/Package	Absorbs/Pkg. (gal.)	Qty./Pallet	Compatibility	Incinerable?	Page #
GRB150H	HeavyWeight Roll	30" x 150'	1	55.2 gal.	15	W, O, S	yes	8-9
GRSB150H	HeavyWeight Split Rolls	15" x 150'	2	55.2 gal.	15	W, O, S	yes	8-9
GRB150M	MediumWeight Roll	30" x 150'	1	46.1 gal.	21	W, O, S	yes	8-9
GRB300S	LightWeight Roll	30" x 300'	1	59.1 gal.	15	W, O, S	yes	8-9

Universal COMMANDER™ Mat Pads		Gray Universal (for oils, coolants, solvents & water)						Pages 10-11
Item #	Description	Size	Units/Package	Absorbs/Pkg. (gal.)	Qty./Pallet	Compatibility	Incinerable?	Page #
GPF100H	HeavyWeight Pads	15" x 19"	100	26.3 gal.	30	W, O, S	yes	10-11
GPF1014H	HeavyWeight Pads	10" x 14"	100	18.1 gal.	60	W, O, S	yes	10-11
GPF100H-BX	HeavyWeight Pads in Dispenser Box	15" x 19"	100	26.3 gal.	30	W, O, S	yes	10-11
GPKF50H	HeavyWeight King Pads	30" x 30"	50	41.6 gal.	15	W, O, S	yes	10-11
GPF100M	MediumWeight Pads	15" x 19"	100	20.8 gal.	36	W, O, S	yes	10-11
GPF200S	LightWeight Pads	15" x 19"	200	28.1 gal.	30	W, O, S	yes	10-11

Universal COMMANDER™ Mat Rolls		Gray Universal (for oils, coolants, solvents & water)						Pages 10-11
Item #	Description	Size	Units/Package	Absorbs/Pkg. (gal.)	Qty./Pallet	Compatibility	Incinerable?	Page #
GRF150H	HeavyWeight Roll	30" x 150'	1	49.8 gal.	15	W, O, S	yes	10-11
GRF24150H	HeavyWeight Roll	24" x 150'	1	39.8 gal.	18	W, O, S	yes	10-11
GRF100H-BX	HeavyWeight Roll in Dispenser Box	15" x 100'	1	19.3 gal.	30	W, O, S	yes	10-11
GRSF150H	HeavyWeight Split Rolls	15" x 150'	2	49.8 gal.	15	W, O, S	yes	10-11
GRFF50H	HeavyWeight Folded Roll in Disp Box	5" x 50'	1	8.4 gal.	42	W, O, S	yes	10-11
GRF150M	MediumWeight Roll	30" x 150'	1	39.5 gal.	21	W, O, S	yes	10-11
GRSF150M	MediumWeight Split Rolls	15" x 150'	2	39.5 gal.	21	W, O, S	yes	10-11
GRF300S	LightWeight Roll	30" x 300'	1	53.4 gal.	15	W, O, S	yes	10-11
GRSF300S	LightWeight Split Rolls	15" x 300'	2	53.4 gal.	15	W, O, S	yes	10-11
GRSF1550S	LightWeight Mini Rolls	15" x 50'	12	53.4 gal.	12	W, O, S	yes	10-11

Universal COMMANDER™ Mat Pads		Green Universal (for oils, coolants, solvents & water)						Pages 10-11
Item #	Description	Size	Units/Package	Absorbs/Pkg. (gal.)	Qty./Pallet	Compatibility	Incinerable?	Page #
GNPF100H	HeavyWeight Pads	15" x 19"	100	26.3 gal.	30	W, O, S	yes	10-11
GNPF100H-BX	HeavyWeight Pads in Dispenser Box	15" x 19"	100	26.3 gal.	30	W, O, S	yes	10-11
GNPF100M	MediumWeight Pads	15" x 19"	100	20.8 gal.	36	W, O, S	yes	10-11

Universal COMMANDER™ Mat Rolls		Green Universal (for oils, coolants, solvents & water)						Pages 10-11
Item #	Description	Size	Units/Package	Absorbs/Pkg. (gal.)	Qty./Pallet	Compatibility	Incinerable?	Page #
GNRF150H	HeavyWeight Roll	30" x 150'	1	49.8 gal.	15	W, O, S	yes	10-11
GNRSF150H	HeavyWeight Split Rolls	15" x 150'	2	49.8 gal.	15	W, O, S	yes	10-11

Compatibility: A-Aggressive S-Solvents O-Oil W-water

Complete Product SpecSheet

Universal Drip, Rip and Go™ Tablets Gray Universal (for oils, coolants, solvents & water) Pages 10-11

Item #	Description	Size	Units/Package	Absorbs/Pkg. (gal.)	Qty./Pallet	Compatibility	Incinerable?	Page #
GPF20S	LightWeight Pads	15" x 19"	20 pads/tablet 9 tablets/pkg	25.2 gal.	24	W, O, S	yes	10-11

Universal PROTECTOR™ Mat Pads Gray Universal (for oils, coolants, solvents & water) Pages 12-13

Item #	Description	Size	Units/Package	Absorbs/Pkg. (gal.)	Qty./Pallet	Compatibility	Incinerable?	Page #
GPL100H	HeavyWeight Pads	15" x 19"	100	28.9 gal.	30	W, O, S	yes	12-13
GPL100M	MediumWeight Pads	15" x 19"	100	23.4 gal.	36	W, O, S	yes	12-13

Universal PROTECTOR™ Mat Rolls Gray Universal (for oils, coolants, solvents & water) Pages 12-13

Item #	Description	Size	Units/Package	Absorbs/Pkg. (gal.)	Qty./Pallet	Compatibility	Incinerable?	Page #
GRL150H	HeavyWeight Roll	30" x 150'	1	54.9 gal.	15	W, O, S	yes	12-13
GRSL150H	HeavyWeight Split Rolls	15" x 150'	2	54.9 gal.	15	W, O, S	yes	12-13
GRL150M	MediumWeight Roll	30" x 150'	1	44.4 gal.	21	W, O, S	yes	12-13
GRSL150M	MediumWeight Split Rolls	15" x 150'	2	44.4 gal.	21	W, O, S	yes	12-13

Universal CAUTION Mat Pads Yellow Universal (for oils, coolants, solvents & water) Pages 14-15

Item #	Description	Size	Units/Package	Absorbs/Pkg. (gal.)	Qty./Pallet	Compatibility	Incinerable?	Page #
YPZ100H-BX	HeavyWeight Pads	15" x 19"	100	29.1 gal.	30	W, O, S	yes	14-15
YPZ100M-BX	MediumWeight Pads	15" x 19"	100	24.7 gal.	36	W, O, S	yes	14-15
YPZ200S-BX	LightWeight Pads	15" x 19"	200	31.1 gal.	30	W, O, S	yes	14-15
YPZ25S-BX	LightWeight Pads	15" x 19"	25 pads/box 5 box/pkg.	38.9 gal.	30	W, O, S	yes	14-15
YPZ100S-BX	LightWeight Pads	15" x 19"	100	15.6 gal.	36	W, O, S	yes	14-15

Universal CAUTION Mat Rolls Yellow Universal (for oils, coolants, solvents & water) Pages 14-15

Item #	Description	Size	Units/Package	Absorbs/Pkg. (gal.)	Qty./Pallet	Compatibility	Incinerable?	Page #
YRZ150H	HeavyWeight Roll	30" x 150'	1	55.2 gal.	15	W, O, S	yes	14-15
YRZ100H-BX	HeavyWeight Roll	15" x 100'	1	18.9 gal.	30	W, O, S	yes	14-15
YRSZ150H	HeavyWeight Split Rolls	15" x 150'	2	55.2 gal.	15	W, O, S	yes	14-15
YRZ150M	MediumWeight Roll	30" x 150'	1	46.1 gal.	21	W, O, S	yes	14-15
YRSZ150M	MediumWeight Split Rolls	15" x 150'	2	46.1 gal.	21	W, O, S	yes	14-15
YRSZ150M-1	MediumWeight Roll	15" x 150'	1	23 gal.	36	W, O, S	yes	14-15
YRZ300M	MediumWeight Roll	30" x 300'	1	92.2 gal.	12	W, O, S	yes	14-15

Universal MAXIMIZER Mat Pads Gray Universal (for oils, coolants, solvents & water) Pages 16-17

Item #	Description	Size	Units/Package	Absorbs/Pkg. (gal.)	Qty./Pallet	Compatibility	Incinerable?	Page #
GPC75H	HeavyWeight Pads	15" x 19"	75	27.5 gal.	18	W, O, S	yes	16-17
GPC100S	LightWeight Pads	15" x 19"	100	24.0 gal.	24	W, O, S	yes	16-17

Universal MAXIMIZER Mat Rolls Gray Universal (for oils, coolants, solvents & water) Pages 16-17

Item #	Description	Size	Units/Package	Absorbs/Pkg. (gal.)	Qty./Pallet	Compatibility	Incinerable?	Page #
GRC150H	HeavyWeight Roll	30" x 150'	1	69.0 gal.	8	W, O, S	yes	16-17
GRC150S	LightWeight Roll	30" x 150'	1	44.0 gal.	12	W, O, S	yes	16-17

Universal SURVIVOR™ Mat Pads Gray Universal (for oils, coolants, solvents & water) Page 18

Item #	Description	Size	Units/Package	Absorbs/Pkg. (gal.)	Qty./Pallet	Compatibility	Incinerable?	Page #
SVP100H	HeavyWeight Pads	15" x 19"	100	17.9 gal.	30	W, O, S	yes	18

Universal SURVIVOR™ Mat Rolls Gray Universal (for oils, coolants, solvents & water) Page 18

Item #	Description	Size	Units/Package	Absorbs/Pkg. (gal.)	Qty./Pallet	Compatibility	Incinerable?	Page #
SVR150H	HeavyWeight Roll	30" x 150'	1	35.8 gal.	15	W, O, S	yes	18
SVRS150H-1	HeavyWeight Roll	15" x 150'	1	17.9 gal.	30	W, O, S	yes	18
SVRS150H-2	HeavyWeight Split Rolls	15" x 150'	2	35.8 gal.	15	W, O, S	yes	18

Universal TRANSFORMER™ Mat Roll Gray Universal (for oils, coolants, solvents & water) Page 19

Item #	Description	Size	Units/Package	Absorbs/Pkg. (gal.)	Qty./Pallet	Compatibility	Incinerable?	Page #
GRSMF100H-BX	HeavyWeight Roll in Dispenser Box	15" x 100'	1	18.9 gal.	30	W, O, S	yes	19

Universal DrumTop Pads Gray Universal (for oils, coolants, solvents & water) Page 19

Item #	Description	Size	Units/Package	Absorbs/Pkg. (gal.)	Qty./Pallet	Compatibility	Incinerable?	Page #
GTOP	HeavyWeight Pads	22" Dia.	25	8.6 gal.	72	W, O, S	yes	19

Universal COMMANDER™ Rolls & Magnet Dispenser Gray Universal (for oils, coolants, solvents & water) Page 20

Item #	Description	Size	Units/Package	Absorbs/Pkg. (gal.)	Qty./Pallet	Compatibility	Incinerable?	Page #
GRSF1550S	LightWeight Mini Rolls	15" x 50'	12	53.4 gal.	12	W, O, S	yes	20
A-MAGRACK	Roll Holder Dispenser with Magnets	5.5" x 17" x 2"	1	n/a	228	n/a	no	20

Universal Socks Gray Universal (for oils, coolants, solvents & water) Page 21

Item #	Description	Size	Units/Package	Absorbs/Pkg. (gal.)	Qty./Pallet	Compatibility	Incinerable?	Page #
GS0410	Universal Socks	3" x 4'	10	8.3 gal.	35	W, O, S	yes	21
GS0430	Universal Socks	3" x 4'	30	25 gal.	16	W, O, S	yes	21
GS0815	Universal Socks	3" x 8'	15	25 gal.	16	W, O, S	yes	21
GS01210	Universal Socks	3" x 12'	10	25 gal.	16	W, O, S	yes	21

Universal CornCob Socks Gray Universal (for oils, coolants, solvents & water) Page 21

Item #	Description	Size	Units/Package	Absorbs/Pkg. (gal.)	Qty./Pallet	Compatibility	Incinerable?	Page #
CCS040	CornCob Socks	3" x 42"	40	20.0 gal.	16	W, O, S	yes	21

Universal Boom Gray Universal (for oils, coolants, solvents & water) Page 22

Item #	Description	Size	Units/Package	Absorbs/Pkg. (gal.)	Qty./Pallet	Compatibility	Incinerable?	Page #
GB510SN	Universal Booms	5" x 10'	4	23.3 gal.	20	W, O, S	yes	22

Universal Pillows Gray Universal (for oils, coolants, solvents & water) Page 22

Item #	Description	Size	Units/Package	Absorbs/Pkg. (gal.)	Qty./Pallet	Compatibility	Incinerable?	Page #
GPIL1818	Universal Pillows	18" x 18"	10	23.0 gal.	35	W, O, S	yes	22
GPIL818	Universal Pillows	8" x 18"	20	23.0 gal.	35	W, O, S	yes	22
GPIL1010	Universal Pillows	10" x 10"	40	30.0 gal.	35	W, O, S	yes	22

Oil-Dri™ Loose Sorbent Universal (for oils, coolants, solvents & water) Page 23

Item #	Description	Size	Units/Package	Absorbs/Pkg. (gal.)	Qty./Pallet	Compatibility	Incinerable?	Page #
NEW CLAY32	Oil-Dri™ Loose Sorbent	35-lb. Bag	1	3.75 gal.	60	W, O, S	yes	23

Universal Pans Universal (for oils, coolants, solvents & water) Page 22

Item #	Description	Size	Units/Package	Absorbs/Pkg. (gal.)	Qty./Pallet	Compatibility	Incinerable?	Page #
GPIL1224	Universal Pillow in a Pan	10.5" sq. x 3"H	12 pans & 24 pillows	18.0 gal.	35	W, O, S	yes	22
GPIL1010	Universal Pillows Refill	10" x 10"	40	30.0 gal.	35	W, O, S	yes	22
DPU-16	Universal DripPans	10.5" sq. x 3"H	16	12.0 gal.	20	W, O, S	no	22

Gran-sorb® Loose Sorbent Universal (for oils, coolants, solvents & water) Page 23

Item #	Description	Size	Units/Package	Absorbs/Pkg. (gal.)	Qty./Pallet	Compatibility	Incinerable?	Page #
CELL30	Gran-sorb® Loose Sorbent	30-lb. Bag	65	4.0 gal.	65	W, O, S	yes	23

Loose CornCob Universal (for oils, coolants, solvents & water) Page 23

Item #	Description	Size	Units/Package	Absorbs/Pkg. (gal.)	Qty./Pallet	Compatibility	Incinerable?	Page #
COB40	Loose CornCob	40-lb. Bag	50	8.5 gal.	50	W, O, S	yes	23

Lite-Zorb Loose Sorbent Universal (for oils, coolants, solvents & water) Page 23

Item #	Description	Size	Units/Package	Absorbs/Pkg. (gal.)	Qty./Pallet	Compatibility	Incinerable?	Page #
MR1020	Lite-Zorb Loose Sorbent	25-lb. Bag	1	5.4 gal.	80	W, O, S	yes	23

SuperSorb Loose Sorbent Universal (for oils, coolants, solvents & water) Page 23

Item #	Description	Size	Units/Package	Absorbs/Pkg. (gal.)	Qty./Pallet	Compatibility	Incinerable?	Page #
SS1	SuperSorb Loose Sorbent	28-oz. Shakers	1	0.6 gal.	720	W, O, S	yes	23
SS12	SuperSorb Loose Sorbent	28-oz. Shakers (12)	60	7.0 gal.	60	W, O, S	yes	23
SS5	SuperSorb Loose Sorbent	5-gal. Pail	40	6.0 gal.	60	W, O, S	yes	23

Fluidloc™ Sorbent (for water-based liquids) Page 23

Item #	Description	Size	Units/Package	Absorbs/Pkg. (gal.)	Qty./Pallet	Compatibility	Incinerable?	Page #
FL1	Fluidloc™ Sorbent	48-oz. Shakers	1	13.5 gal.	1,584	W, O, S	yes	23
FL12	Fluidloc™ Sorbent	48-oz. Shakers	12	162.0 gal.	132	W, O, S	yes	23

Oil-Only CONTRACTOR GRADE Mat Pads White Oil-Only (for oils, not water) Pages 24-25

Item #	Description	Size	Units/Package	Absorbs/Pkg. (gal.)	Qty./Pallet	Compatibility	Incinerable?	Page #
WP-H	HeavyWeight Pads	15" x 18"	100	22.0 gal.	42	0	yes	24-25
WP-M	MediumWeight Pads	15" x 18"	100	30.0 gal.	48	0	yes	24-25
WP-S	LightWeight Pads	15" x 18"	200	35.0 gal.	30	0	yes	24-25

A - Aggressive
 S - Solvents
 O - Oil
 W - Water
 Compatibility:
 Complete Product SpecSheet

Oil-Only CONTRACTOR GRADE Mat Rolls White Oil-Only (for oils, not water) Pages 24-25

Item #	Description	Size	Units/Package	Absorbs/Pkg. (gal.)	Qty./Pallet	Compatibility	Incinerable?	Page #
WR-H	HeavyWeight Roll	30" x 150'	1	44.0 gal.	21	0	yes	24-25
WR-M	MediumWeight Roll	30" x 150'	1	40.0 gal.	21	0	yes	24-25

Oil-Only RESPONDER™ Mat Pads White Oil-Only (for oils, not water) Pages 26-27

Item #	Description	Size	Units/Package	Absorbs/Pkg. (gal.)	Qty./Pallet	Compatibility	Incinerable?	Page #
WP100H	HeavyWeight Pads	15" x 19"	100	33.4 gal.	30	0	yes	26-27
WPK50H	HeavyWeight King Pads	30" x 30"	50	52.8 gal.	15	0	yes	26-27
WP100M	MediumWeight Pads	15" x 19"	100	26.7 gal.	36	0	yes	26-27
WP100S	LightWeight Pads	15" x 19"	100	17.9 gal.	48	0	yes	26-27
WP200S	LightWeight Pads	15" x 19"	200	35.7 gal.	30	0	yes	26-27

Oil-Only RESPONDER™ Mat Rolls White Oil-Only (for oils, not water) Pages 26-27

Item #	Description	Size	Units/Package	Absorbs/Pkg. (gal.)	Qty./Pallet	Compatibility	Incinerable?	Page #
WR150H	HeavyWeight Roll	30" x 150'	1	63.4 gal.	15	0	yes	26-27
WRS150H	HeavyWeight Split Rolls	15" x 150'	2	63.4 gal.	15	0	yes	26-27
WR150M	MediumWeight Roll	30" x 150'	1	50.7 gal.	21	0	yes	26-27
WR300S	LightWeight Roll	30" x 300'	1	67.9 gal.	15	0	yes	26-27

Oil-Only DEFENDER™ Mat Pads White Oil-Only (for oils, not water) Pages 28-29

Item #	Description	Size	Units/Package	Absorbs/Pkg. (gal.)	Qty./Pallet	Compatibility	Incinerable?	Page #
WPB100H	HeavyWeight Pads	15" x 19"	100	29.1 gal.	30	0	yes	28-29
WPB50H	HeavyWeight Pads	15" x 19"	50	14.6 gal.	48	0	yes	28-29
WPKB50H	HeavyWeight King Pads	30" x 30"	50	45.3 gal.	15	0	yes	28-29
WPB100M	MediumWeight Pads	15" x 19"	100	24.7 gal.	36	0	yes	28-29
WPB50M	MediumWeight Pads	15" x 19"	50	12.4 gal.	48	0	yes	28-29
WPB200S	LightWeight Pads	15" x 19"	200	31.1 gal.	30	0	yes	28-29
WPB100S	LightWeight Pads	15" x 19"	100	15.6 gal.	48	0	yes	28-29

Oil-Only DEFENDER™ Mat Rolls White Oil-Only (for oils, not water) Pages 28-29

Item #	Description	Size	Units/Package	Absorbs/Pkg. (gal.)	Qty./Pallet	Compatibility	Incinerable?	Page #
WRB150H	HeavyWeight Roll	30" x 150'	1	55.2 gal.	15	0	yes	28-29
WRSB150H	HeavyWeight Split Rolls	15" x 150'	2	55.2 gal.	15	0	yes	28-29
WRB150M	MediumWeight Roll	30" x 150'	1	46.1 gal.	21	0	yes	28-29
WRSB150M	MediumWeight Split Rolls	15" x 150'	2	46.1 gal.	21	0	yes	28-29
WRB300S	LightWeight Roll	30" x 300'	1	59.1 gal.	15	0	yes	28-29

Oil-Only COMMANDER™ Mat Pads White Oil-Only (for oils, not water) Pages 30-31

Item #	Description	Size	Units/Package	Absorbs/Pkg. (gal.)	Qty./Pallet	Compatibility	Incinerable?	Page #
WPF100H	HeavyWeight Pads	15" x 19"	100	26.3 gal.	30	0	yes	30-31
WPF1014H	HeavyWeight Pads	10" x 14"	100	18.1 gal.	60	0	yes	30-31
WPF100H-BX	HeavyWeight Pads in Dispenser Box	15" x 19"	100	26.3 gal.	30	0	yes	30-31
WPKF50H	HeavyWeight King Pads	30" x 30"	50	41.6 gal.	15	0	yes	30-31
WPF100M	MediumWeight Pads	15" x 19"	100	20.8 gal.	36	0	yes	30-31
WPF200S	LightWeight Pads	15" x 19"	200	28.1 gal.	30	0	yes	30-31

Oil-Only COMMANDER™ Mat Rolls White Oil-Only (for oils, not water) Pages 30-31

Item #	Description	Size	Units/Package	Absorbs/Pkg. (gal.)	Qty./Pallet	Compatibility	Incinerable?	Page #
WRF150H	HeavyWeight Roll	30" x 150'	1	49.8 gal.	15	0	yes	30-31
WRF100H-BX	HeavyWeight Roll in Dispenser Box	15" x 100'	1	19.3 gal.	30	0	yes	30-31
WRSF150H	HeavyWeight Split Rolls	15" x 150'	2	49.8 gal.	15	0	yes	30-31
WRF150M	MediumWeight Roll	30" x 150'	1	39.5 gal.	21	0	yes	30-31

Oil-Only COMMANDER™ Mat Pads Blue Oil-Only (for oils, not water) Pages 30-31

Item #	Description	Size	Units/Package	Absorbs/Pkg. (gal.)	Qty./Pallet	Compatibility	Incinerable?	Page #
BPF100H	HeavyWeight Pads	15" x 19"	100	26.3 gal.	30	0	yes	30-31
BPF100H-BX	HeavyWeight Pads in Dispenser Box	15" x 19"	100	26.3 gal.	30	0	yes	30-31
BPF200S	LightWeight Pads	15" x 19"	200	28.1 gal.	30	0	yes	30-31

Oil-Only COMMANDER™ Mat Roll Blue Oil-Only (for oils, not water) Pages 30-31

Item #	Description	Size	Units/Package	Absorbs/Pkg. (gal.)	Qty./Pallet	Compatibility	Incinerable?	Page #
BRF150H	HeavyWeight Roll	30" x 150'	1	49.8 gal.	15	0	yes	30-31

Oil-Only PROTECTOR™ Mat Pads		White Oil-Only (for oils, not water)						Pages 32-33	
Item #	Description	Size	Units/Package	Absorbs/Pkg. (gal.)	Qty./Pallet	Compatibility	Incinerable?	Page #	
WPL100H	HeavyWeight Pads	15" x 19"	100	28.9 gal.	30	0	yes	32-33	
WPL100M	MediumWeight Pads	15" x 19"	100	23.4 gal.	36	0	yes	32-33	

Oil-Only PROTECTOR™ Mat Rolls		White Oil-Only (for oils, not water)						Pages 32-33	
Item #	Description	Size	Units/Package	Absorbs/Pkg. (gal.)	Qty./Pallet	Compatibility	Incinerable?	Page #	
WRL150H	HeavyWeight Roll	30" x 150'	1	54.9 gal.	15	0	yes	32-33	
WRSL150H	HeavyWeight Split Rolls	15" x 150'	2	54.9 gal.	15	0	yes	32-33	
WRL150M	MediumWeight Roll	30" x 150'	1	44.4 gal.	21	0	yes	32-33	
WRSL150M	MediumWeight Split Rolls	15" x 150'	2	44.4 gal.	21	0	yes	32-33	

Oil-Only PROTECTOR™ Mat Pads		Blue Oil-Only (for oils, not water)						Pages 32-33	
Item #	Description	Size	Units/Package	Absorbs/Pkg. (gal.)	Qty./Pallet	Compatibility	Incinerable?	Page #	
BPL100H	HeavyWeight Pads	15" x 19"	100	28.9 gal.	30	0	yes	32-33	

Oil-Only ARRESTOR™ Mat Pads		White Oil-Only (for oils, not water)						Page 34	
Item #	Description	Size	Units/Package	Absorbs/Pkg. (gal.)	Qty./Pallet	Compatibility	Incinerable?	Page #	
WPX50H	HeavyWeight Pads	15" x 19"	50	16.8 gal.	60	0	yes	34	
WPX100H	HeavyWeight Pads	15" x 19"	100	33.6 gal.	30	0	yes	34	

Oil-Only ARRESTOR™ Mat Rolls		White Oil-Only (for oils, not water)						Page 34	
Item #	Description	Size	Units/Package	Absorbs/Pkg. (gal.)	Qty./Pallet	Compatibility	Incinerable?	Page #	
WRX150H	HeavyWeight Roll	30" x 150'	1	63.4 gal.	15	0	yes	34	

Oil-Only TRANSFORMER™ Mat		White Oil-Only (for oils, not water)						Page 35	
Item #	Description	Size	Units/Package	Absorbs/Pkg. (gal.)	Qty./Pallet	Compatibility	Incinerable?	Page #	
WRSMF100H-BX	HeavyWeight Roll in Dispenser Box	15" x 100'	1	18.9 gal.	30	0	yes	35	

Oil-Only DrumTop Pads		Blue Oil-Only (for oils, not water)						Pages 36	
Item #	Description	Size	Units/Package	Absorbs/Pkg. (gal.)	Qty./Pallet	Compatibility	Incinerable?	Page #	
BTOP	Oil-Only Drum Top Pads	22"Dia.	25	8.6 gal.	72	0	yes	36	

Rig Mats		Blue Oil-Only (for oils, not water)						Pages 36	
Item #	Description	Size	Units/Package	Absorbs/Pkg. (gal.)	Qty./Pallet	Compatibility	Incinerable?	Page #	
RIG160H	HeavyWeight Roll	58" x 160'	1	176.2 gal.	6	0	yes	36	

Oil-Only Socks		White Oil-Only (for oils, not water)						Page 37	
Item #	Description	Size	Units/Package	Absorbs/Pkg. (gal.)	Qty./Pallet	Compatibility	Incinerable?	Page #	
WSO410	Oil-Only Socks	3" x 4'	10	8.33 gal.	35	0	yes	37	
WSO430	Oil-Only Socks	3" x 4'	30	25.0 gal.	16	0	yes	37	
WSO815	Oil-Only Socks	3" x 8'	15	25.0 gal.	16	0	yes	37	
WSO1210	Oil-Only Socks	3" x 12'	10	25.0 gal.	16	0	yes	37	

Oil-Only Pillows		White Oil-Only (for oils, not water)						Page 37	
Item #	Description	Size	Units/Package	Absorbs/Pkg. (gal.)	Qty./Pallet	Compatibility	Incinerable?	Page #	
WPIL1818	Oil-Only Pillows	18" x 18"	10	23.0 gal.	35	0	yes	37	
WPIL818	Oil-Only Pillows	8" x 18"	20	23.0 gal.	35	0	yes	37	
WPIL1010	Oil-Only Pillows	10" x 10"	40	30.0 gal.	35	0	yes	37	

Oil-Only Pillow in a Pan		Oil-Only (for oils, not water)						Page 37	
Item #	Description	Size	Units/Package	Absorbs/Pkg. (gal.)	Qty./Pallet	Compatibility	Incinerable?	Page #	
WPIL1224	Oil-Only Pillow in a Pan	10.5" sq. x 3"H	12 pans & 24 pillows	18.0 gal.	35	0	yes	37	
WPIL1010	Oil-Only Pillows Refills	10" x 10"	40	30.0 gal.	35	0	yes	37	
DPO-16	Oil-Only DripPans	10.5" sq. x 3"H	16	12.0 gal.	20	0	yes	37	

Oil-Only PREMIUM Booms		White Oil-Only (for oils, not water)						Pages 38-39
Item #	Description	Size	Units/Package	Absorbs/Pkg. (gal.)	Qty./Pallet	Compatibility	Incinerable?	Page #
PREM510	Premium Booms	5" x 10'	4	30.0 gal.	20	0	yes	38-39
PREM810	Premium Booms	8" x 10'	4	38.0 gal.	12	0	yes	38-39

Oil-Only CONTRACTOR GRADE Booms		White Oil-Only (for oils, not water)						Page 39
Item #	Description	Size	Units/Package	Absorbs/Pkg. (gal.)	Qty./Pallet	Compatibility	Incinerable?	Page #
WB410SN	Sock/Net Booms	4" x 10'	4	19.5 gal.	24	0	yes	39
WB510SN	Sock/Net Booms	5" x 10'	4	30.0 gal.	20	0	yes	39
WB520SN	Sock/Net Booms	5" x 20'	2	30.0 gal.	20	0	yes	39
WB810SN	Sock/Net Booms	8" x 10'	4	38.0 gal.	12	0	yes	39
WB820SN	Sock/Net Booms	8" x 20'	2	38.0 gal.	12	0	yes	39

PomPoms		White Oil-Only (for oils, not water)						Page 40
Item #	Description	Size	Units/Package	Absorbs/Pkg. (gal.)	Qty./Pallet	Compatibility	Incinerable?	Page #
APMPM	PomPoms/30 individual	n/a	30	11.6 gal.	30	0	yes	40
APMPM-R	PomPoms/30 on 50' rope	n/a	1	11.6 gal.	30	0	yes	40

Bilge Booms		White Oil-Only (for oils, not water)						Page 40
Item #	Description	Size	Units/Package	Absorbs/Pkg. (gal.)	Qty./Pallet	Compatibility	Incinerable?	Page #
WBB318	Bilge Booms	3" x 18"	20	6.25 gal.	30	0	yes	40
WBB818	Bilge Booms	8" x 18"	10	18.0 gal.	20	0	yes	40

Net Bags		White Oil-Only (for oils, not water)						Page 40
Item #	Description	Size	Units/Package	Absorbs/Pkg. (gal.)	Qty./Pallet	Compatibility	Incinerable?	Page #
WPIL10	Net Bags	6"D x 16"W x 21"H	10	37.0 gal.	15	0	yes	40

Folded Sweep		White Oil-Only (for oils, not water)						Page 40
Item #	Description	Size	Units/Package	Absorbs/Pkg. (gal.)	Qty./Pallet	Compatibility	Incinerable?	Page #
WSWL100F	Folded Sweep	19"W x 100'L	1	25.3 gal.	36	0	yes	40

Loose Sorbents		Oil-Only (for oils, not water)						Page 40
Item #	Description	Size	Units/Package	Absorbs/Pkg. (gal.)	Qty./Pallet	Compatibility	Incinerable?	Page #
PEAT2	Loose PeatMoss	2 cu. ft.	1	16.0 gal.	54	0	yes	40

Containment Booms		Containment & Anchor System (non-absorbent)						Page 41
Item #	Description	Size	Units/Package	Qty./Pallet	Compatibility	Incinerable?	Page #	
C-BOOM10-50	Containment Boom	50'L x 10"H (4" float, 6" skirt)	1	20	N/A	no	41	
C-BOOM10-100	Containment Boom	100'L x 10"H (4" float, 6" skirt)	1	10	N/A	no	41	
C-BOOM18-50	Containment Boom	50'L x 18"H (6" float, 12" skirt)	1	16	N/A	no	41	
C-BOOM18-100	Containment Boom	100'L x 18"H (6" float, 12" skirt)	1	6	N/A	no	41	
C-BOOM24-50	Containment Boom	50'L x 24"H (8" float, 16" skirt)	1	12	N/A	no	41	
C-BOOM24-100	Containment Boom	100'L x 24"H (8" float, 16" skirt)	1	6	N/A	no	41	
C-ANCHOR2	Containment Boom Anchor System	88 lb. anchor system	1	3	N/A	no	41	

HazMat DEFENDER™ Mat Pads		Yellow HazMat (for acids, bases & unknown liquids)						Pages 42-43
Item #	Description	Size	Units/Package	Absorbs/Pkg. (gal.)	Qty./Pallet	Compatibility	Incinerable?	Page #
YPB100H	HeavyWeight Pads	15" x 19"	100	29.1 gal.	30	A, W, O, S	yes	42-43
YPB50H	HeavyWeight Pads	15" x 19"	50	14.6 gal.	48	A, W, O, S	yes	42-43
YPB100M	MediumWeight Pads	15" x 19"	100	24.7 gal.	36	A, W, O, S	yes	42-43
YPB50M	MediumWeight Pads	15" x 19"	50	12.4 gal.	48	A, W, O, S	yes	42-43
YPB200S	LightWeight Pads	15" x 19"	200	31.1 gal.	30	A, W, O, S	yes	42-43
YPB100S	LightWeight Pads	15" x 19"	100	15.5 gal.	48	A, W, O, S	yes	42-43

HazMat DEFENDER™ Mat Rolls		Yellow HazMat (for acids, bases & unknown liquids)						Pages 42-43
Item #	Description	Size	Units/Package	Absorbs/Pkg. (gal.)	Qty./Pallet	Compatibility	Incinerable?	Page #
YRB150H	HeavyWeight Roll	30" x 150'	1	55.2 gal.	15	A, W, O, S	yes	42-43
YRSB150H	HeavyWeight Split Rolls	15" x 150'	2	55.2 gal.	15	A, W, O, S	yes	42-43
YRB150M	MediumWeight Roll	30" x 150'	1	46.1 gal.	21	A, W, O, S	yes	42-43

HazMat COMMANDER™ Mat Pads		Yellow HazMat (for acids, bases & unknown liquids)						Pages 44-45
Item #	Description	Size	Units/Package	Absorbs/Pkg. (gal.)	Qty./Pallet	Compatibility	Incinerable?	Page #
YPF100H	HeavyWeight Pads	15" x 19"	100	26.3 gal.	30	A, W, O, S	yes	44-45
YPF1014H	HeavyWeight Pads	10" x 14"	100	18.1 gal.	60	A, W, O, S	yes	44-45

HazMat COMMANDER™ Mat Rolls		Yellow HazMat (for acids, bases & unknown liquids)						Pages 44-45
Item #	Description	Size	Units/Package	Absorbs/Pkg. (gal.)	Qty./Pallet	Compatibility	Incinerable?	Page #
YRF150H	HeavyWeight Roll	30" x 150'	1	49.8 gal.	15	A, W, O, S	yes	44-45
YRSF150H	HeavyWeight Split Rolls	15" x 150'	2	49.8 gal.	15	A, W, O, S	yes	44-45

HazMat Poly Blend Socks		Yellow HazMat (for acids, bases & unknown liquids)						Page 46
Item #	Description	Size	Units/Package	Absorbs/Pkg. (gal.)	Qty./Pallet	Compatibility	Incinerable?	Page #
YSO410	HazMat Socks	3" x 4'	10	8.33 gal.	35	A, W, O, S	yes	46
YSO430	HazMat Socks	3" x 4'	30	25.0 gal.	16	A, W, O, S	yes	46
YSO815	HazMat Socks	3" x 8'	15	25.0 gal.	16	A, W, O, S	yes	46
YSO1210	HazMat Socks	3" x 12'	10	25.0 gal.	16	A, W, O, S	yes	46

HazMat Sock/Net Booms		Yellow HazMat (for acids, bases & unknown liquids)						Page 46
Item #	Description	Size	Units/Package	Absorbs/Pkg. (gal.)	Qty./Pallet	Compatibility	Incinerable?	Page #
HZ510SN	HazMat Booms	5" x 10'	4	23.3 gal.	20	A, W, O, S	yes	46
HZ810SN	HazMat Booms	8" x 10'	4	33.9 gal.	12	C	yes	46

HazMat Poly Blend Pillows		Yellow HazMat (for acids, bases & unknown liquids)						Page 46
Item #	Description	Size	Units/Package	Absorbs/Pkg. (gal.)	Qty./Pallet	Compatibility	Incinerable?	Page #
YPIL818	HazMat Pillows	8" x 18"	20	26.8 gal.	35	A, W, O, S	yes	46
YPIL1818	HazMat Pillows	18" x 18"	10	29.1 gal.	35	A, W, O, S	yes	46

Acid Neutralizing Sorbents		Acid Neutralizing Sorbents						Pages 47
Item #	Description	Size	Units/Package	Absorbs/Pkg. (gal.)	Qty./Pallet	Compatibility	Incinerable?	Page #
ANS1	Acid Neutralizing Sorbent	32 oz. Shaker	1	.2 gal.	720	A	yes	47
ANS12	Acid Neutralizing Sorbent	32 oz. Shaker	12	2.4 gal.	60	A	yes	47
ANS5	Acid Neutralizing Sorbent	5-gal. Pail	1	2.5 gal.	40	A	yes	47

Battery Acid Neutralizer		Neutralizing Sorbents						Pages 47
Item #	Description	Size	Units/Package	Absorbs/Pkg. (gal.)	Qty./Pallet	Compatibility	Incinerable?	Page #
BAN1	Battery Acid Neutralizer	32 oz. Spray Bottle	1	n/a	576	A	no	47
BAN12	Battery Acid Neutralizer	32 oz. Spray Bottle	12	n/a	48	A	no	47

Multi-Purpose Neutralizing Spill Kit		Neutralizing Sorbents						Pages 48
Item #	Description	Size	Units/Package	Absorbs/Pkg. (gal.)	Qty./Pallet	Compatibility	Incinerable?	Page #
MPN-KIT	Multi-Purpose Neutralizing Spill Kit	3.5-gal Pail	1	2.5 gal./kit	48	A	no	48

Base Neutralizer		Neutralizing Sorbents						Pages 48
Item #	Description	Size	Units/Package	Absorbs/Pkg. (gal.)	Qty./Pallet	Compatibility	Incinerable?	Page #
BN1	Base Neutralizer	1.5 lb. Shaker	1	.5 gal.	576	A	yes	48
BN6	Base Neutralizer	1.5 lb. Shaker	6	3 gal.	96	A	yes	48

A - Aggressive

S - Solvents

O - Oil

W - Water

Compatibility:

Complete Product SpecSheet

Hydrofluoric Acid Neutralizer		Neutralizing Sorbents						Pages 48
Item #	Description	Size	Units/Package	Absorbs/Pkg. (gal.)	Qty./Pallet	Compatibility	Incinerable?	Page #
HFN1	Hydrofluoric Acid Neutralizer	1.5 lb. Shaker	1	.5 gal.	576	A	yes	48
HFN6	Hydrofluoric Acid Neutralizer	1.5 lb. Shaker	6	3 gal.	96	A	yes	48

Pad Box		Flat Pad Box						Page 49
Item #	Description	Size	Units/Package	Absorbs/Pkg. (gal.)	Qty./Pallet	Compatibility	Incinerable?	Page #
A-PADBOX	Pad Box	15.5"L x 19.25"W x 16"H	1	n/a	150	n/a	yes	49

Free-Standing RollRack		Free-Standing RollRack						Page 49
Item #	Description	Size	Units/Package	Absorbs/Pkg. (gal.)	Qty./Pallet	Compatibility	Incinerable?	Page #
A-ROLLRACK2	Free-Standing RollRack	For rolls up to 32"W	1	n/a	72	n/a	no	49

Universal FLOOR GRABBER™ High-Traffic Mat		Gray and Black Universal (for oils, coolants, solvents & water)						Pages 52-53
Item #	Description	Size	Units/Package	Absorbs/Pkg. (gal.)	Qty./Pallet	Compatibility	Incinerable?	Page #
NRT100S-BK	MediumWeight Roll	36" x 100'	1	8 gal.	18	W, O, S	yes	52-53
NRT100S-GY	MediumWeight Roll	36" x 100'	1	8 gal.	18	W, O, S	yes	52-53
NRT50S-BK	MediumWeight Roll	36" x 50'	1	4 gal.	28	W, O, S	yes	52-53
NRT50S-GY	MediumWeight Roll	36" x 50'	1	4 gal.	28	W, O, S	yes	52-53
NRT24100S-BK	MediumWeight Roll	24" x 100'	1	5.3 gal.	32	W, O, S	yes	52-53
NRT24100S-GY	MediumWeight Roll	24" x 100'	1	5.3 gal.	32	W, O, S	yes	52-53

Universal FLOOR GRABBER™ High-Traffic Hi-Viz Mat		Black Universal (for oils, coolants, solvents & water)						Pages 52-53
Item #	Description	Size	Units/Package	Absorbs/Pkg. (gal.)	Qty./Pallet	Compatibility	Incinerable?	Page #
NEW NRT100S-HV	MediumWeight Roll	36" x 100'	1	8 gal.	18	W, O, S	yes	52-53

Universal FLOOR GRABBER™ High-Traffic Carpet Mat		Gray Universal (for oils, coolants, solvents & water)						Pages 54-55
Item #	Description	Size	Units/Package	Absorbs/Pkg. (gal.)	Qty./Pallet	Compatibility	Incinerable?	Page #
NRT25H-GY	MediumWeight Roll	36" x 25'	1	6.8 gal.	23	W, O, S	yes	54-55

Universal TUFF Rug®		Gray Universal (for oils, coolants, solvents & water)						Page 56
Item #	Description	Size	Units/Package	Absorbs/Pkg. (gal.)	Qty./Pallet	Compatibility	Incinerable?	Page #
MR2069	HeavyWeight Mat Roll	33" x 150'	1	23.0 gal.	24	W, O, S	yes	56

Universal Traffic TUFF Rug®		Gray Universal (for oils, coolants, solvents & water)						Page 56
Item #	Description	Size	Units/Package	Absorbs/Pkg. (gal.)	Qty./Pallet	Compatibility	Incinerable?	Page #
NPR150H-GR	HeavyWeight Roll	36" x 150'	1	54.0 gal.	12	W, O, S	yes	56
NPR300S-GR	LightWeight Roll	36" x 300'	1	54.0 gal.	12	W, O, S	yes	56
PBR100	PolyBacked Roll	36" x 100'	1	13.0 gal.	20	W, O, S	yes	56

Universal Recycled TUFF Rug®		Gray Universal (for oils, coolants, solvents & water)						Page 57
Item #	Description	Size	Units/Package	Absorbs/Pkg. (gal.)	Qty./Pallet	Compatibility	Incinerable?	Page #
RRUG36H	HeavyWeight Roll	36" x 150'	1	84.6 gal.	12	W, O, S	yes	57
RRUG18H	HeavyWeight Split Rolls	18" x 150'	2	84.6 gal.	12	W, O, S	yes	57

Universal Recycled Traffic TUFF Rug®		Gray Universal (for oils, coolants, solvents & water)						Page 57
Item #	Description	Size	Units/Package	Absorbs/Pkg. (gal.)	Qty./Pallet	Compatibility	Incinerable?	Page #
NEW NPRR72H	HeavyWeight Roll	72" x 150'	1	100 gal.	6	W, O, S	yes	57
NEW NPRR36H	HeavyWeight Roll	36" x 150'	1	50 gal.	12	W, O, S	yes	57

TrackMat and Railroad Mat			Black Oil-Only (for oils, not water)					Page 58
Item #	Description	Size	Units/Package	Absorbs/Pkg. (gal.)	Qty./Pallet	Compatibility	Incinerable?	Page #
TMAT57	HeavyWeight TrackMat Roll	57" x 80'	15	63.2 gal.	6	0	yes	58
TMAT19	HeavyWeight TrackMat Split Rolls	19" x 80'	15	41.7 gal.	12	0	yes	58
RRMAT60	RailRoad Mat Roll	59" x 100'	1	63.0 gal.	15	0	yes	58
RRMAT19	RailRoad Mat Rolls	19" x 100'	2	42.0 gal.	6	0	yes	58

Series 300 DRC Wipers			Universal (for oils, coolants, solvents & water)					Page 60	
Item #	Description	Style	Color	Size	Units/Package	Qty./Pallet	Performance Rating	Compatibility	Page #
WPR301	Light-Duty Wipers	Jumbo Roll	White	11.312" x 13.25"	950/roll; 1 roll; 950 wipers	45	300	W, O, S	60

Series 350 Airlaid Wipers			Universal (for oils, coolants, solvents & water)					Page 60	
Item #	Description	Style	Color	Size	Units/Package	Qty./Pallet	Performance Rating	Compatibility	Page #
WPR500	Light-Duty Wipers	1/4-Fold	White	11.5" x 13"	25/pack; 36 packs; 900 wipers	27	350	W, O, S	60

Series 450 DRC Wipers			Universal (for oils, coolants, solvents & water)					Page 61	
Item #	Description	Style	Color	Size	Units/Package	Qty./Pallet	Performance Rating	Compatibility	Page #
NEW WIP1302	Medium-Duty Wipers	Pop-up	White	15" x 9"	100/box; 9 boxes; 900 wipers	32	450	W, O, S	61
WPR308	Medium-Duty Wipers	Roll	White	11.812" x 6.625"	415/roll; 2 rolls; 830 wipers	63	450	W, O, S	61
WPR508	Medium-Duty Wipers	C-Pull Roll	White	8.875" x 13.25"	225/roll; 1 roll; 225 wipers	140	450	W, O, S	61

Series 700 Spunlace Wipers			Universal (for oils, coolants, solvents & water)					Page 62	
Item #	Description	Style	Color	Size	Units/Package	Qty./Pallet	Performance Rating	Compatibility	Page #
NEW WIP396	Heavy-Duty Wipers	Roll	Blue	15" x 12"	440/roll; 1 roll; 440 wipers	120	700	W, O, S	62
NEW WIP1000	Heavy-Duty Wipers	1/4-Fold	Blue	14" x 13"	50/pack; 20 packs; 1000 wipers	32	700	W, O, S	62
NEW WIP1105	Heavy-Duty Wipers	Roll	Red	13" x 12"	475/roll; 1 roll; 475 wipers	72	700	W, O, S	62
WPR205	Heavy-Duty Wipers	Z-Fold	White	12" x 12.5"	200/box; 1 box; 200 wipers	180	700	W, O, S	62

SPILL KITS / 95-Gallon			95-Gallon Spill Kits					Page 64
Item #	Description	Size	Refill Kit #	Absorbs/Pkg. (gal.)	Qty./Pallet	Compatibility	Incinerable?	Page #
SPKU-95	95-Gallon Kit/Universal	31.75"Dia. x 41.5"H	RSPKU-95	79.7 gal.	2	W, O, S	no	64
RSPKU-95	Refill Kit for 95-Gallon Kit/Universal	<i>Call for shipping info</i>	n/a	79.7 gal.	8	W, O, S	no	64
SPKO-95	95-Gallon Kit/Oil-Only	31.75"Dia. x 41.5"H	RSPKO-95	79.7 gal.	2	0	no	64
RSPKO-95	95-Gallon Kit/Oil-Only	<i>Call for shipping info</i>	n/a	79.7 gal.	8	0	no	64
SPKHZ-95	95-Gallon Kit/HazMat	31.75"Dia. x 41.5"H	RSPKHZ-95	79.7 gal.	2	A, W, O, S	no	64
RSPKHZ-95	Refill Kit for 95-Gallon Kit/HazMat	<i>Call for shipping info</i>	n/a	79.7 gal.	8	A, W, O, S	no	64
A95OVER	95-Gallon Empty OverPack	32"Dia. x 41.5"H	n/a	n/a	Nest 4 High	n/a	no	64

SPILL KITS / 95-Gallon Wheeled			95-Gallon Spill Kits with Wheels					Page 64
Item #	Description	Size	Refill Kit #	Absorbs/Pkg. (gal.)	Qty./Pallet	Compatibility	Incinerable?	Page #
SPKU-95-WD	95-Gallon Kit/Universal w/Wheels	32"Dia. x 47"H	RSPKU-95	79.7 gal.	1	W, O, S	no	64
RSPKU-95	Refill Kit for 95-Gallon Kit/Universal	<i>Call for shipping info</i>	n/a	79.7 gal.	8	W, O, S	no	64
SPKO-95-WD	95-Gallon Kit/Oil-Only w/Wheels	32"Dia. x 47"H	RSPKO-95	79.7 gal.	1	0	no	64
RSPKO-95	95-Gallon Kit/Oil-Only	<i>Call for shipping info</i>	n/a	79.7 gal.	8	0	no	64
SPKHZ-95-WD	95-Gallon Kit/HazMat w/Wheels	32"Dia. x 47"H	RSPKHZ-95	79.7 gal.	1	A, W, O, S	no	64
RSPKHZ-95	Refill Kit for 95-Gallon Kit/HazMat	<i>Call for shipping info</i>	n/a	79.7 gal.	8	A, W, O, S	no	64
A95OVER-WD	Empty 95-Gallon OverPack w/ Wheels	32"Dia. x 47.5"H	n/a	n/a	Nest 4 High	n/a	no	64

SPILL KITS / 65-Gallon		65-Gallon Spill Kits						Page 65
Item #	Description	Size	Refill Kit #	Absorbs/Pkg. (gal.)	Qty./Pallet	Compatibility	Incinerable?	Page #
SPKU-65	65-Gallon Kit/Universal	28.25"Dia. x 37.37"H	RSPKU-65	43.8 gal.	2	W, O, S	no	65
RSPKU-65	Refill Kit for 65-Gallon Kit/Universal	<i>Call for shipping info</i>	n/a	43.8 gal.	12	W, O, S	no	65
SPKO-65	65-Gallon Kit/Oil-Only	28.25"Dia. x 37.37"H	RSPKO-65	43.8 gal.	2	O	no	65
RSPKO-65	Refill for 65-Gallon Kit/Oil-Only	<i>Call for shipping info</i>	n/a	43.8 gal.	12	O	no	65
SPKHZ-65	65-Gallon Kit/HazMat	28.25"Dia. x 37.37"H	RSPKHZ-65	43.8 gal.	2	A, W, O, S	no	65
RSPKHZ-65	Refill Kit for 65-Gallon Kit/HazMat	<i>Call for shipping info</i>	n/a	43.8 gal.	12	A, W, O, S	no	65
A65OVER	65-Gallon Empty OverPack	28.25"Dia. x 37.5"H	n/a	n/a	6	n/a	no	65

SPILL KITS / 55-Gallon		55-Gallon Spill Kits						Page 65
Item #	Description	Size	Refill Kit #	Absorbs/Pkg. (gal.)	Qty./Pallet	Compatibility	Incinerable?	Page #
SPKU-55	55-Gallon Kit/Universal	24"Dia. x 40"H	RSPKU-55	48.9 gal.	8	W, O, S	no	65
RSPKU-55	Refill Kit for 55-Gallon Kit/Universal	<i>Call for shipping info</i>	n/a	48.9 gal.	16	W, O, S	yes	65
SPKO-55	55-Gallon Kit/Oil-Only	24"Dia. x 40"H	RSPKO-55	48.9 gal.	8	O	no	65
RSPKO-55	Refill for 55-Gallon Kit/Oil-Only	<i>Call for shipping info</i>	n/a	48.9 gal.	16	O	yes	65
SPKHZ-55	55-Gallon Kit/HazMat	24"Dia. x 40"H	RSPKHZ-55	48.9 gal.	8	A, W, O, S	no	65
RSPKHZ-55	Refill Kit for 55-Gallon Kit/HazMat	<i>Call for shipping info</i>	n/a	48.9 gal.	16	A, W, O, S	yes	65
A55DRUM	55-Gallon Empty OverPack	24"Dia. x 40"H	n/a	n/a	36	n/a	no	65

SPILL KITS / 50-Gallon Wheeled		50-Gallon Spill Kits with Wheels						Page 65
Item #	Description	Size	Refill Kit #	Absorbs/Pkg. (gal.)	Qty./Pallet	Compatibility	Incinerable?	Page #
SPKU-50-WD	50-Gallon Kit/Universal w/wheels	24.5"Dia. x 39.5"H	RSPKU-50	43.3 gal.	4	W, O, S	no	65
RSPKU-50	Refill Kit for 50-Gallon Kit/Universal	<i>Call for shipping info</i>	n/a	43.3 gal.	10	W, O, S	no	65
SPKO-50-WD	50-Gallon Kit/Oil-Only w/wheels	24.5"Dia. x 39.5"H	RSPKO-50	43.3 gal.	4	O	no	65
RSPKO-50	Refill for 50-Gallon Kit/Oil-Only	<i>Call for shipping info</i>	n/a	43.3 gal.	10	O	no	65
SPKHZ-50-WD	50-Gallon Kit/HazMat w/wheels	24.5"Dia. x 39.5"H	RSPKHZ-50	43.3 gal.	4	A, W, O, S	no	65
RSPKHZ-50	Refill Kit for 50-Gallon Kit/HazMat	<i>Call for shipping info</i>	n/a	43.3 gal.	10	A, W, O, S	no	65
A50OVER-WD	50-Gallon Empty OverPack w/wheels	24.5"Dia. x 45.5"H	n/a	n/a	6	n/a	no	65

SPILL KITS / 30-Gallon		30-Gallon Spill Kits						Page 66
Item #	Description	Size	Refill Kit #	Absorbs/Pkg. (gal.)	Qty./Pallet	Compatibility	Incinerable?	Page #
SPKU-30	30-Gallon Kit/Universal	23"Dia. x 30"H	RSPKU-30	23.1 gal.	8	W, O, S	no	66
RSPKU-30	Refill Kit for 30-Gallon Kit/Universal	<i>Call for shipping info</i>	n/a	23.1 gal.	30	W, O, S	no	66
SPKO-30	30-Gallon Kit/Oil-Only	23"Dia. x 30"H	RSPKO-30	23.1 gal.	8	O	no	66
RSPKO-30	Refill for 30-Gallon Kit/Oil-Only	<i>Call for shipping info</i>	n/a	23.1 gal.	30	O	no	66
SPKHZ-30	30-Gallon Kit/HazMat	23"Dia. x 30"H	RSPKHZ-30	23.1 gal.	8	A, W, O, S	no	66
RSPKHZ-30	Refill Kit for 30-Gallon Kit/HazMat	<i>Call for shipping info</i>	n/a	23.1 gal.	30	A, W, O, S	no	66
A30OVER	30-Gallon Empty OverPack	23"Dia. x 30"H	n/a	n/a	24	n/a	no	66

SPILL KITS / 20-Gallon		20-Gallon Spill Kits						Page 66
Item #	Description	Size	Refill Kit #	Absorbs/Pkg. (gal.)	Qty./Pallet	Compatibility	Incinerable?	Page #
SPKU-20	20-Gallon Kit/Universal	23"Dia. x 19"H	RSPKU-20	15.2 gal.	16	W, O, S	no	66
RSPKU-20	Refill Kit for 20-Gallon Kit/Universal	<i>Call for shipping info</i>	n/a	15.2 gal.	32	W, O, S	no	66
SPKO-20	20-Gallon Kit/Oil-Only	23"Dia. x 19"H	RSPKO-20	15.2 gal.	16	O	no	66
RSPKO-20	Refill for 20-Gallon Kit/Oil-Only	<i>Call for shipping info</i>	n/a	15.2 gal.	32	O	no	66
SPKHZ-20	20-Gallon Kit/HazMat	23"Dia. x 19"H	RSPKHZ-20	15.2 gal.	16	A, W, O, S	no	66
RSPKHZ-20	Refill Kit for 20-Gallon Kit/HazMat	<i>Call for shipping info</i>	n/a	15.2 gal.	32	A, W, O, S	no	66
A20OVER	20-Gallon Empty OverPack	23"Dia. x 19"H	n/a	n/a	40	n/a	no	66

SPILL KITS / 10-Gallon		10-Gallon Spill Kits						Page 66
Item #	Description	Size	Refill Kit #	Absorbs/Pkg. (gal.)	Qty./Pallet	Compatibility	Incinerable?	Page #
SPKU-10	10-Gallon Kit/Universal	15"Dia. x 18.3"H	RSPKU-10	9.5 gal.	24	W, O, S	no	66
RSPKU-10	Refill Kit for 10-Gallon Kit/Universal	<i>Call for shipping info</i>	n/a	9.5 gal.	35	W, O, S	no	66
SPKO-10	10-Gallon Kit/Oil-Only	15"Dia. x 18.3"H	RSPKO-10	9.5 gal.	24	0	no	66
RSPKO-10	Refill Kit for 10-Gallon Kit/Oil-Only	<i>Call for shipping info</i>	n/a	9.5 gal.	35	0	no	66
SPKHZ-10	10-Gallon Kit/HazMat	15"Dia. x 18.3"H	RSPKHZ-10	9.5 gal.	24	A, W, O, S	no	66
RSPKHZ-10	Refill Kit for 10-Gallon Kit/HazMat	<i>Call for shipping info</i>	n/a	9.5 gal.	35	A, W, O, S	no	66
A10DRUM	10-Gallon Empty OverPack	15"Dia. x 18.3"H	n/a	n/a	81	n/a	no	66

SPILL KITS / 50-Gallon Wheeled		50-Gallon Wheeled Spill Kits						Page 67
Item #	Description	Size	Refill Kit #	Absorbs/Pkg. (gal.)	Qty./Pallet	Compatibility	Incinerable?	Page #
SPKU-CAN-WD	50-Gallon Kit/Universal w/wheels	29"L x 23.5"W x 36.75"H	RSPKU-CAN	45.9 gal.	2	W, O, S	no	67
RSPKU-CAN	Refill Kit for 50-Gallon Kit/Universal	<i>Call for shipping info</i>	n/a	45.9 gal.	16	W, O, S	no	67
SPKO-CAN-WD	50-Gallon Kit/Oil-Only w/wheels	29"L x 23.5"W x 36.75"H	RSPKO-CAN	45.9 gal.	2	0	no	67
RSPKO-CAN	Refill Kit for 50-Gallon Kit/Oil-Only	<i>Call for shipping info</i>	n/a	45.9 gal.	16	0	no	67
SPKHZ-CAN-WD	50-Gallon Kit/HazMat w/wheels	29"L x 23.5"W x 36.75"H	RSPKHZ-CAN	44.7 gal.	2	A, W, O, S	no	67
RSPKHZ-CAN	Refill Kit for 50-Gallon Kit/HazMat	<i>Call for shipping info</i>	n/a	44.7 gal.	16	A, W, O, S	no	67
A50CAN-WD	50-Gallon Empty Container w/wheels	29"L x 23.5"W x 36.75"H	n/a	n/a	10	n/a	no	67

SPILL KITS / Spill Kaddie		Spill Kaddie Kits						Page 67
Item #	Description	Size	Refill Kit #	Absorbs/Pkg. (gal.)	Qty./Pallet	Compatibility	Incinerable?	Page #
SPKU-KAD2	Spill Kaddie Kit/Universal	40"H x 20"W x 20"D	RSPKU-KAD	27.7 gal.	8	W, O, S	no	67
RSPKU-KAD	Refill Kit for Spill Kaddie Kit/Universal	<i>Call for shipping info</i>	n/a	27.7 gal.	30	W, O, S	no	67
SPKO-KAD2	Spill Kaddie Kit/Oil-Only	40"H x 20"W x 20"D	RSPKO-KAD	27.7 gal.	8	0	no	67
RSPKO-KAD	Refill for Spill Kaddie Kit/Oil-Only	<i>Call for shipping info</i>	n/a	27.7 gal.	30	0	no	67
SPKHZ-KAD2	Spill Kaddie Kit/HazMat	40"H x 20"W x 20"D	RSPKHZ-KAD	27.7 gal.	8	A, W, O, S	no	67
RSPKHZ-KAD	Refill Kit for Spill Kaddie Kit/HazMat	<i>Call for shipping info</i>	n/a	27.7 gal.	30	A, W, O, S	no	67
A-KADDIE	Empty Spill Kaddie	40"H x 20"W x 20"D	n/a	n/a	8	n/a	no	67

SPILL KITS / 95-Gallon Hi Viz		95-Gallon Hi Viz Spill Kits						Page 69
Item #	Description	Size	Refill Kit #	Absorbs/Pkg. (gal.)	Qty./Pallet	Compatibility	Incinerable?	Page #
SPKU-95-HV	95-Gallon Hi Viz Kit/Universal	31.75"Dia. x 41.5"H	RSPKU-95	79.7 gal.	2	W, O, S	no	69
RSPKU-95	Refill Kit for 95-Gallon Hi Viz Kit/Universal	<i>Call for shipping info</i>	n/a	79.7 gal.	8	W, O, S	no	69
SPKO-95-HV	95-Gallon Hi Viz Kit/Oil-Only	31.75"Dia. x 41.5"H	RSPKO-95	79.7 gal.	2	0	no	69
RSPKO-95	Refill Kit for 95-Gallon Hi Viz Kit/Oil-Only	<i>Call for shipping info</i>	n/a	79.7 gal.	8	0	no	69
SPKHZ-95-HV	95-Gallon Hi Viz Kit/HazMat	31.75"Dia. x 41.5"H	RSPKHZ-95	79.7 gal.	2	A, W, O, S	no	69
RSPKHZ-95	Refill Kit for 95-Gallon Hi Viz Kit/HazMat	<i>Call for shipping info</i>	n/a	79.7 gal.	8	A, W, O, S	no	69
A95OVER-HV	95-Gallon Empty Hi Viz OverPack	31.75"Dia. x 41.5"H	n/a	n/a	3	n/a	no	69

SPILL KITS / 65-Gallon Hi Viz		65-Gallon Hi Viz Spill Kits						Page 69
Item #	Description	Size	Refill Kit #	Absorbs/Pkg. (gal.)	Qty./Pallet	Compatibility	Incinerable?	Page #
SPKU-65-HV	65-Gallon Hi Viz Kit/Universal	28.25"Dia. x 37.5"H	RSPKU-65	43.8 gal.	2	W, O, S	no	69
RSPKU-65	Refill Kit for 65-Gallon Hi Viz Kit/Universal	<i>Call for shipping info</i>	n/a	43.8 gal.	12	W, O, S	no	69
SPKO-65-HV	65-Gallon Hi Viz Kit/Oil-Only	28.25"Dia. x 37.5"H	RSPKO-65	43.8 gal.	2	0	no	69
RSPKO-65	Refill Kit for 65-Gallon Hi Viz Kit/Oil-Only	<i>Call for shipping info</i>	n/a	43.8 gal.	12	0	no	69
SPKHZ-65-HV	65-Gallon Hi Viz Kit/HazMat	28.25"Dia. x 37.5"H	RSPKHZ-65	43.8 gal.	2	A, W, O, S	no	69
RSPKHZ-65	Refill Kit for 65-Gallon Hi Viz Kit/HazMat	<i>Call for shipping info</i>	n/a	43.8 gal.	12	A, W, O, S	no	69
A65OVER-HV	65-Gallon Empty Hi Viz OverPack	28.25"Dia. x 37.5"H	n/a	n/a	6	n/a	no	69

SPILL KITS / 30-Gallon Hi Viz		30-Gallon Hi Viz Spill Kits						Page 69
Item #	Description	Size	Refill Kit #	Absorbs/Pkg. (gal.)	Qty./Pallet	Compatibility	Incinerable?	Page #
SPKU-30-HV	30-Gallon Hi Viz Kit/Universal	23"Dia. x 30"H	RSPKU-30	23.1 gal.	8	W, O, S	no	69
RSPKU-30	Refill Kit for 30-Gallon Hi Viz Kit/Universal	<i>Call for shipping info</i>	n/a	23.1 gal.	30	W, O, S	no	69
SPKO-30-HV	30-Gallon Hi Viz Kit/Oil-Only	23"Dia. x 30"H	RSPKO-30	23.1 gal.	8	0	no	69
RSPKO-30	Refill Kit for 30-Gallon Hi Viz Kit/Oil-Only	<i>Call for shipping info</i>	n/a	23.1 gal.	30	0	no	69
SPKHZ-30-HV	30-Gallon Hi Viz Kit/HazMat	23"Dia. x 30"H	RSPKHZ-30	23.1 gal.	8	A, W, O, S	no	69
RSPKHZ-30	Refill Kit for 30-Gallon Hi Viz Kit/HazMat	<i>Call for shipping info</i>	n/a	23.1 gal.	30	A, W, O, S	no	69
A30OVER-HV	30-Gallon Empty Hi Viz OverPack	23"Dia. x 30"H	n/a	n/a	24	n/a	no	69

SPILL KITS / 20-Gallon Hi Viz		20-Gallon Hi Viz Spill Kits						Page 69
Item #	Description	Size	Refill Kit #	Absorbs/Pkg. (gal.)	Qty./Pallet	Compatibility	Incinerable?	Page #
SPKU-20-HV	20-Gallon Hi Viz Kit/Universal	23"Dia. x 19.5"H	RSPKU-20	15.2 gal.	16	W, O, S	no	69
RSPKU-20	Refill Kit for 20-Gallon Hi Viz Kit/Universal	<i>Call for shipping info</i>	n/a	15.2 gal.	32	W, O, S	no	69
SPKO-20-HV	20-Gallon Hi Viz Kit/Oil-Only	23"Dia. x 19.5"H	RSPKO-20	15.2 gal.	16	0	no	69
RSPKO-20	Refill Kit for 20-Gallon Hi Viz Kit/Oil-Only	<i>Call for shipping info</i>	n/a	15.2 gal.	32	0	no	69
SPKHZ-20-HV	20-Gallon Hi Viz Kit/HazMat	23"Dia. x 19.5"H	RSPKHZ-20	15.2 gal.	16	A, W, O, S	no	69
RSPKHZ-20	Refill Kit for 20-Gallon Hi Viz Kit/HazMat	<i>Call for shipping info</i>	n/a	15.2 gal.	32	A, W, O, S	no	69
A20OVER-HV	20-Gallon Empty Hi Viz OverPack	23"Dia. x 19.5"H	n/a	n/a	40	n/a	no	69

SPILL KITS / Spill Cart		Spill Cart Kits						Page 70
Item #	Description	Size	Refill Kit #	Absorbs/Pkg. (gal.)	Qty./Pallet	Compatibility	Incinerable?	Page #
SPKU-CART5	Spill Cart Kit/Universal w/ 5" Wheels	38"H x 48"W x 31"D	RSPKU-CART	88.56 gal.	1	W, O, S	no	70
SPKU-CART8	Spill Cart Kit/Universal w/ 8" Wheels	41"H x 48"W x 31"D	RSPKU-CART	88.56 gal.	1	W, O, S	no	70
RSPKU-CART	Refill Kit for Cart Kit/Universal	<i>Call for shipping info</i>	n/a	88.56 gal.	6	W, O, S	no	70
SPKO-CART5	Spill Cart Kit/Oil-Only w/ 5" Wheels	38"H x 48"W x 31"D	RSPKO-CART	109.9 gal.	1	0	no	70
SPKO-CART8	Spill Cart Kit/Oil-Only w/ 8" Wheels	41"H x 48"W x 31"D	RSPKO-CART	109.9 gal.	1	0	no	70
RSPKO-CART	Refill for Cart Kit/Oil-Only	<i>Call for shipping info</i>	n/a	109.9 gal.	6	0	no	70
SPKHZ-CART5	Spill Cart Kit/HazMat w/ 5" Wheels	38"H x 48"W x 31"D	RSPKHZ-CART	86.0 gal.	1	A, W, O, S	no	70
SPKHZ-CART8	Spill Cart Kit/HazMat w/ 8" Wheels	41"H x 48"W x 31"D	RSPKHZ-CART	86.0 gal.	1	A, W, O, S	no	70
RSPKHZ-CART	Refill Kit for Cart Kit/HazMat	<i>Call for shipping info</i>	n/a	86.0 gal.	7	A, W, O, S	no	70
A-UTILITYBOX5	Empty Utility Box w/ 5" Wheels	38"H x 48"W x 31"D	n/a	15 Cu. Ft Capacity	Nest 5 High	n/a	no	70
A-UTILITYBOX8	Empty Utility Box w/ 8" Wheels	41"H x 48"W x 31"D	n/a	15 Cu. Ft Capacity	Nest 5 High	n/a	no	70

SPILL KITS / Forklift		Forklift Spill Kits						Page 71
Item #	Description	Size	Refill Kit #	Absorbs/Pkg. (gal.)	Qty./Pallet	Compatibility	Incinerable?	Page #
SPKU-LIFT	Forklift Kit/Universal	10"Dia. x 22" L	n/a	8.3 gal.	32	W, O, S	no	71
SPKO-LIFT	Forklift Kit/Oil-Only	10"Dia. x 22" L	n/a	8.3 gal.	32	0	no	71
SPKHZ-LIFT	Forklift Kit/HazMat	10"Dia. x 22" L	n/a	8.3 gal.	32	A, W, O, S	no	71

SPILL KITS / Duffle Bag		Duffle Bag Kits						Page 73
Item #	Description	Size	Refill Kit #	Absorbs/Pkg. (gal.)	Qty./Pallet	Compatibility	Incinerable?	Page #
SPKU-DUFF	Duffle Bag Kit/Universal	40"L x 12"W x 12"H	n/a	28.8 gal.	18	W, O, S	no	73
SPKO-DUFF	Duffle Bag Kit/Oil-Only	40"L x 12"W x 12"H	n/a	28.8 gal.	18	0	no	73
A-DUFFLE	Empty Yellow Bag	40"L x 12"W x 12"H	n/a	n/a	400	n/a	no	73

SPILL KITS / Black Bag		Duffle Bag Kits						Page 73
Item #	Description	Size	Refill Kit #	Absorbs/Pkg. (gal.)	Qty./Pallet	Compatibility	Incinerable?	Page #
SPKU-BLK-BG	Black Bag Kit/Universal	18"L x 11"W x 11"H	n/a	9 gal.	35	W, O, S	no	73
SPKO-BLK-BG	Black Bag Kit/Oil-Only	18"L x 11"W x 11"H	n/a	9 gal.	35	0	no	73
A-BLACKBAG	Empty Black Bag	18"L x 11"W x 11"H	n/a	n/a	400	n/a	no	73

SPILL KITS / Tote		Tote Spill Kits						Page 74
Item #	Description	Size	Refill Kit #	Absorbs/Pkg. (gal.)	Qty./Pallet	Compatibility	Incinerable?	Page #
SPKU-GTOTE	Tote Kit/Universal	20"L x 15"W x 4"H	n/a	4.6 gal.	32	W, O, S	no	74
SPKO-GTOTE	Tote Kit/Oil-Only	20"L x 15"W x 4"H	n/a	4.6 gal.	32	0	no	74
SPKHZ-GTOTE	Tote Kit/HazMat	20"L x 15"W x 4"H	n/a	4.6 gal.	32	A, W, O, S	no	74
A-GTOTE	Empty Tote Bag	20"L x 15"W x 4"H	n/a	n/a	2016	n/a	no	74

SPILL KITS / Foil Bag		Foil Bag Spill Kits						Page 74
Item #	Description	Size	Refill Kit #	Absorbs/Pkg. (gal.)	Qty./Pallet	Compatibility	Incinerable?	Page #
NEW SPKU-FOILB	Foil Bag Kit/Universal	20"L x 21"W x 7.5"D	n/a	4.8 gal.	100	W, O, S	no	74
NEW SPKO-FOILB	Foil Bag Kit/Oil-Only	20"L x 21"W x 7.5"D	n/a	4.8 gal.	100	0	no	74
NEW SPKHZ-FOILB	Foil Bag Kit/HazMat	20"L x 21"W x 7.5"D	n/a	4 gal.	100	A, W, O, S	no	74

SPILL KITS / Emergency		Emergency Spill Kits							Page 75
Item #	Description	Size	Refill Kit #	Absorbs/Pkg. (gal.)	Qty./Pallet	Compatibility	Incinerable?	Page #	
SPKU-OBAG	Orange Emergency Bag Kit/Universal	12"L x 18"W x 4"H	n/a	4.1 gal.	128	W, O, S	no	75	
SPKO-OBAG	Orange Emergency Bag Kit/Oil-Only	12"L x 18"W x 4"H	n/a	4.1 gal.	128	0	no	75	
SPKU-YBAG	Yellow Emergency Bag Kit/Universal	12"L x 18"W x 4"H	n/a	4.1 gal.	128	W, O, S	no	75	
SPKO-YBAG	Yellow Emergency Bag Kit/Oil-Only	12"L x 18"W x 4"H	n/a	4.1 gal.	128	0	no	75	
SPKHZ-YBAG	Yellow Emergency Bag Kit/HazMat	12"L x 18"W x 4"H	n/a	4.1 gal.	128	A, W, O, S	no	75	

SPILL KITS / Fleet		Fleet Kits							Page 75
Item #	Description	Size	Refill Kit #	Absorbs/Pkg. (gal.)	Qty./Pallet	Compatibility	Incinerable?	Page #	
SPKU-FLEET	Fleet Kit/Universal	20"H x 17"W x 8"D	n/a	10.7 gal.	32	W, O, S	no	75	
SPKO-FLEET	Fleet Kit/Oil-Only	20"H x 17"W x 8"D	n/a	10.7 gal.	32	0	no	75	
SPKHZ-FLEET	Fleet Kit/HazMat	20"H x 17"W x 8"D	n/a	10.7 gal.	32	A, W, O, S	no	75	
A-YTOTE	Empty Tote Bag	20"H x 17"W x 8"D	n/a	n/a	1000	n/a	no	75	

SPILL KITS / 5-Gallon		5-Gallon Spill Kits							Page 76
Item #	Description	Size	Refill Kit #	Absorbs/Pkg. (gal.)	Qty./Pallet	Compatibility	Incinerable?	Page #	
SPKU-5	5-Gallon Kit/Universal	12"Dia. x 16.75"H	n/a	4.6 gal.	24	W, O, S	no	76	
SPKO-5	5-Gallon Kit/Oil-Only	12"Dia. x 16.75"H	n/a	4.6 gal.	24	0	no	76	
SPKHZ-5	5-Gallon Kit/HazMat	12"Dia. x 16.75"H	n/a	4.6 gal.	24	A, W, O, S	no	76	
A5OVER	Empty Spill 5-Gallon Pail	12"Dia. x 16.75"H	n/a	n/a	72	n/a	no	76	

SPILL KITS / Trucker		Trucker Spill Kits							Page 76
Item #	Description	Size	Refill Kit #	Absorbs/Pkg. (gal.)	Qty./Pallet	Compatibility	Incinerable?	Page #	
SPKU-TRK	Trucker Kit/Universal	18"H x 15"W x 6"D	n/a	8.3 gal.	54	W, O, S	no	76	
SPKO-TRK	Trucker Kit/Oil-Only	18"H x 15"W x 6"D	n/a	8.3 gal.	54	0	no	76	
SPKHZ-TRK	Trucker Kit/HazMat	18"H x 15"W x 6"D	n/a	8.3 gal.	54	A, W, O, S	no	76	

SPILL KITS / Single Use		Single Use Kits							Page 76
Item #	Description	Size	Refill Kit #	Absorbs/Pkg. (gal.)	Qty./Pallet	Compatibility	Incinerable?	Page #	
SPKU-YTB	Spill Kit/Universal	17"L x 23"W x 2"H	n/a	3.7 gal.	90	W, O, S	no	76	
SPKO-YTB	Spill Kit/Oil-Only	17"L x 23"W x 2"H	n/a	3.7 gal.	90	0	no	76	

SPILL KITS / Specialty		Specialty Spill Kits							Page 76
Item #	Description	Size	Refill Kit #	Absorbs/Pkg. (gal.)	Qty./Pallet	Compatibility	Incinerable?	Page #	
SPKU-WCAB	Universal Wall Cabinet Spill Kit	12.75"L x 13.75"W x 30" H	RSPKU-WCAB	22.7 gal.	12	W, O, S	no	76	
A-WCAB	Empty Cabinet	12.75"L x 13.75"W x 30" H	n/a	n/a	12	n/a	no	76	

SPILL KITS / Specialty		Specialty Spill Kits							Page 77
Item #	Description	Size	Refill Kit #	Absorbs/Pkg. (gal.)	Qty./Pallet	Compatibility	Incinerable?	Page #	
PPE-KIT	Personal Protection Spill Kit	17"L x 23"W x 2"D	n/a	n/a	90	n/a	no	77	
MERC-KIT2	Mercury Spill Kit	110"L x 7"W x 9"H	n/a	35.27 oz.	120	Only Mercury	no	77	
SPKHZ-BATT	Battery Acid Spill Kit	23"Dia. x 19"H	RSPKHZ-BATT	21.4 gal.	16	A, W, O, S	no	77	
A20OVER	Empty 20-Gallon OverPack	23"Dia. x 19"H	n/a	n/a	40	n/a	no	77	

Containers		Containers							Pages 78-79
Item #	Description	Size	Units/Pkg.	Capacity (gal.)	Qty./Pallet	Compatibility	Incinerable?	Page #	
A-KADDIE	Empty Spill Kaddie	40"H x 20"W x 20"D	1	n/a	8	n/a	no	78-79	
A-UTILITYBOX5	Empty Spill Cart w/ 5" Wheels	38"H x 48"W x 31"D	1	15 Cu. Ft.	1	n/a	no	78-79	
A-UTILITYBOX8	Empty Spill Cart w/ 8" Wheels	41"H x 48"W x 31"D	1	15 Cu. Ft.	1	n/a	no	78-79	
A-GTOTE	Empty Tote Bag, Green	20"L x 17"W x 8"D	1	n/a	1,000	n/a	no	78-79	
A-YTOTE	Empty Tote Bag, Yellow	20"L x 17"W x 8"D	1	n/a	1,000	n/a	no	78-79	
A-DUFFLE	Empty Yellow Bag	40" L x 12" W x 12" H	1	n/a	400	n/a	no	78-79	
A-BLACKBAG	Empty Black Bag	18"L x 11"W x 11"H	1	n/a	400	n/a	no	78-79	
A-OBAG	Spill Kit Tote Bag, Orange	4" D x 12" L x 18" H	1	n/a	500	n/a	no	78-79	
A-YBAG	Spill Kit Tote Bag, Yellow	4" D x 12" L x 18" H	1	n/a	500	n/a	no	78-79	
A-WCAB	Wall Mount Cabinet	12.75"L x 13.75"W x 30"H	1	n/a	12	n/a	no	78-79	

OverPacks and OverPack Salvage Drums		OverPacks and OverPack Salvage Drums							Page 80
Item #	Description	Size	Units/Pkg.	Capacity (gal.)	Qty./Pallet	Compatibility	Incinerable?	Page #	
A95OVER	95-Gallon OverPack Salvage Drum	32"Dia. x 41.5"H	1	95.0 gal	3	n/a	no	80	
A95OVER-RC	95-Gallon Recycled OverPack Salvage Drum	32.25"Dia. x 41.5"H	1	95.0 gal	4	n/a	no	80	
A95OVER-WD	95-Gallon Wheeled OverPack Salvage Drum	32"Dia. x 47.5"H	1	95.0 gal	3	n/a	no	80	
A65OVER	65-Gallon OverPack Salvage Drum	28.25"Dia. x 37.5"H	1	95.0 gal	6	n/a	no	80	
A55DRUM	55-Gallon OverPack	24"Dia. x 40"H	1	55.0 gal	36	n/a	no	80	
A50OVER-WD	50-Gallon Wheeled OverPack Salvage Drum	24.5"Dia. x 45.5"H	1	50.0 gal	6	n/a	no	80	
A50CAN-WD	50-Gallon Wheeled OverPack	29" x 23.5" x 36.75"	1	50.0 gal	10	n/a	no	80	
A30OVER	30-Gallon OverPack Salvage Drum	23"Dia. x 30"H	1	30.0 gal	24	n/a	no	80	
A20OVER	20-Gallon OverPack Salvage Drum	22"Dia. x 18"H	1	20.0 gal	40	n/a	no	80	
A10DRUM	10-Gallon OverPack	15"Dia. x 18"H	1	10.0 gal	81	n/a	no	80	
A5OVER	5-Gallon OverPack	12"Dia. x 16.75"H	1	5.0 gal	72	n/a	no	80	

Spill Kit Accessory Items		Spill Kit Accessory Items							Page 81
Item #	Description	Size	Units/Pkg.	Absorbs/Pkg. (gal.)	Qty./Pallet	Compatibility	Incinerable?	Page #	
A-TYVEK-L	Coveralls	L	1	n/a	1,000	A, W, O, S	no	81	
A-TYVEK-XL	Coveralls	XL	1	n/a	1,000	A, W, O, S	no	81	
A-APRON-WH	Apron - Enduro 2000™ Fabric	One Size Fits All	1	n/a	5,000	A, W, O, S	no	81	
A-MASK	Dust Mask	One Size Fits All	1	n/a	n/a	A, W, O, S	no	81	
A-GOG	Safety Goggles	One Size Fits All	1	n/a	n/a	n/a	no	81	
A-LATEXBOOTS	Latex Boots	XL	1	n/a	n/a	A, W, O, S	no	81	

Spill Kit Accessory Items		Spill Kit Accessory Items							Page 82
Item #	Description	Size	Units/Pkg.	Absorbs/Pkg. (gal.)	Qty./Pallet	Compatibility	Incinerable?	Page #	
A-GLV-NEO	Gloves - Neoprene	L	1	n/a	n/a	A, W, O, S	no	82	
A-GLV-NIT	Gloves - Nitrile	One Size Fits All	1	n/a	n/a	A, W, O, S	no	82	
A-GLV-NIT-CS	Gloves - Nitrile	One Size Fits All	144	n/a	n/a	A, W, O, S	no	82	
A-EPOXY	Epoxy Putty	7" Stick	1	n/a	n/a	A, W, O, S	no	82	
A-EPOXY-CS	Epoxy Putty	7" Stick	24	n/a	n/a	A, W, O, S	no	82	
A-PND	Plug & Dike Epoxy	3.5"Dia. x 2.5"H, 1 lb.	1	n/a	1,000	A, W, O, S	no	82	
A-WOODPLUGS-SM	Wooden Plugs Small	Assorted .5" to .75"	9	n/a	n/a	n/a	no	82	
A-WOODPLUGS-LG	Wooden Plugs Large	Assorted .5" to 1.75"	9	n/a	n/a	n/a	no	82	
ANS1	Acid Neutralizing Sorbent	32 oz. Shaker	1	.2	720	A	no	82	
SS1	SuperSorbent Loose Sorbent	28-oz. Shaker	1	.6	720	A	no	82	

Spill Kit Accessory Items		Spill Kit Accessory Items							Page 83
Item #	Description	Size	Units/Pkg.	Absorbs/Pkg. (gal.)	Qty./Pallet	Compatibility	Incinerable?	Page #	
WPF1014H	Commander Oil-Only HeavyWeight Pads	10" x 14"	100	18.1 gal.	60	O	yes	83	
GPF1014H	Commander Universal HeavyWeight Pads	10" x 14"	100	18.1 gal.	60	A, W, O, S	yes	83	
YPF1014H	Commander HazMat HeavyWeight Pads	10" x 14"	100	18.1 gal.	60	A, W, O, S	yes	83	
WPR500-1	Series 350 Airlaid Wipers	11.5" x 13"	25	n/a	27	W, O, S	yes	83	
A-COVER-SM	OverPack Cover	for 20- & 30-gal. OverPacks	1	n/a	100	n/a	no	83	
A-COVER-LG	OverPack Cover	for 65- & 95-gal OverPacks	1	n/a	100	n/a	no	83	
A-PHTEST	pH Tester Kit	50'L Tape	1	n/a	n/a	n/a	no	83	
A-LIGHTSTICKS	Light Stick	6"L Stick	1	n/a	n/a	n/a	no	83	

Spill Kit Accessory Items		Spill Kit Accessory Items							Page 84
Item #	Description	Size	Units/Pkg.	Absorbs/Pkg. (gal.)	Qty./Pallet	Compatibility	Incinerable?	Page #	
A-EGB	Emergency GuideBook	384 Pages	1	n/a	n/a	n/a	yes	84	
A-SEAL	TamperProof Seals	2"W x 6"L	6	n/a	n/a	n/a	yes	84	
A-WASTE	Hazardous Waste Label	6"W x 6"L	1	n/a	n/a	n/a	no	84	
A-DISP BAG	Temporary Disposal Bag	30"L x 6"D x 60"H	1	n/a	n/a	W, O, S	no	84	
A-DISP BAG-ROLL	Temporary Disposal Bags	30"L x 6"W x 60"H	125	n/a	n/a	W, O, S	no	84	
A-DISP BAG-SM	Temporary Disposal Bags	18"L x 6"D x 30"H	1	n/a	n/a	W, O, S	no	84	
NEW A-KIT LABEL	Spill Kit Label	3"W x 5"L	1	n/a	n/a	n/a	no	84	
A-SHOVNS	Non-Sparking Shovel	Blade: 10.5"W x 14"H Overall: 43.5"H	1	n/a	n/a	A, W, O, S	no	84	

Roof and Pipe Leak Diverters		Roof and Pipe Leak Diverters						Page 85
Item #	Description	Size	Units/Pkg.	Absorbs/Pkg. (gal.)	Qty./Pallet	Compatibility	Incinerable?	Page #
LD1818	Pipe Leak Diverter	18"L x 18"W	1	n/a	192	W	no	85
LD55	Roof Leak Diverter	5'L x 5'W	1	n/a	480	W	no	85
LD1010	Roof Leak Diverter	10'L x 10'W	1	n/a	192	W	no	85
LDHOSE	Clear Drainage Hose	25'L	1	n/a	288	W	no	85
LDSTRAPS	Rubber Hanging Straps	19"L	4	n/a	999	W	no	85

SpillBerm Plus		SpillBerm Plus						Page 86
Item #	Description	Size	Units/Pkg.	Absorbs/Pkg. (gal.)	Qty./Pallet	Compatibility	Incinerable?	Page #
PBL253	SpillBerm Plus	5'L x 4"W x 4.5"H	1	n/a	32	A, W, O, S	no	86

Connectable Spill Berm		Connectable Spill Berm						Page 86
Item #	Description	Size	Units/Pkg.	Absorbs/Pkg. (gal.)	Qty./Pallet	Compatibility	Incinerable?	Page #
SPB10C	Connectable Spill Berm	10'L x 2.25"W x 1.375"H	1	n/a	28	A, W, O, S	no	86

SpillCurb		SpillCurb						Page 86
Item #	Description	Size	Units/Pkg.	Absorbs/Pkg. (gal.)	Qty./Pallet	Compatibility	Incinerable?	Page #
MR8014	SpillCurb	10"L x 3.75"W x 2.25"H	1	n/a	32	A, W, O, S	no	86
MR8018	SpillCurb Corner	4"L x 3.75"W x 2.25"H	1	n/a	100	A, W, O, S	no	86
MR8019	SpillCurb Connector	4"L x 2.25"H	1	n/a	500	A, W, O, S	no	86

DrainCovers		DrainCovers						Page 87
Item #	Description	Size	Units/Pkg.	Absorbs/Pkg. (gal.)	Qty./Pallet	Compatibility	Incinerable?	Page #
ADC12-CIR	12" DrainCover	12"Dia. x .25"H	1	n/a	40	W, O, S	no	87
ADC36-R	36" DrainCover	36"L x 36"W x .25"H	1	n/a	18	W, O, S	no	87
ADC36-CASE	Case for 36" Cover	7.25"Dia. x 38"L	1	n/a	40	n/a	no	87
ADC42-R	42" DrainCover	42"L x 42"W x .25"H	1	n/a	10	W, O, S	no	87
ADC42-CASE	Case for 42" Cover	7.25"Dia. x 50"L	1	n/a	25	n/a	no	87
ADC48-R	48" DrainCover	48"L x 48"W x .25"H	1	n/a	25	W, O, S	no	87

Conical DrainPlugs		DrainPlugs						Page 87
Item #	Description	Size	Units/Pkg.	Absorbs/Pkg. (gal.)	Qty./Pallet	Compatibility	Incinerable?	Page #
DP2	2" Dia. DrainPlug	2"Dia. x 4.75"H	1	n/a	500	A, W, O, S	no	87
DP3	3" Dia. DrainPlug	3"Dia. x 5"H	1	n/a	500	A, W, O, S	no	87
DP4	4" Dia. DrainPlug	4"Dia. x 5.75"H	1	n/a	500	A, W, O, S	no	87
DP6	6" Dia. DrainPlug	6"Dia. x 5.5"H	1	n/a	500	A, W, O, S	no	87

Ultra-Dewatering Bag®		Ultra-Dewatering Bag®						Page 88
Item #	Description	Size	Units/Pkg.	Absorbs/Pkg. (gal.)	Qty./Pallet	Compatibility	Incinerable?	Page #
ULT9729-OS	Ultra-Dewatering Bag®	3' x 4'	1	n/a	200	W, O	no	88
ULT9724-OS	Ultra-Dewatering Bag®	6' x 6'	1	n/a	80	W, O	no	88
ULT9725-OS	Ultra-Dewatering Bag®	10' x 15'	1	n/a	10	W, O	no	88

Ultra-GutterGuard®		Ultra-GutterGuard®						Page 88
Item #	Description	Size	Units/Pkg.	Absorbs/Pkg. (gal.)	Qty./Pallet	Compatibility	Incinerable?	Page #
ULT9320	Ultra-GutterGuard®	9"Dia. x 8'L	1	n/a	10	W, O	no	88
ULT9321	Ultra-GutterGuard®	9"Dia. x 10'L	1	n/a	10	W, O	no	88
ULT9322	Ultra-GutterGuard®	9"Dia. x 12'L	1	n/a	10	W, O	no	88

Ultra-DrainGuard®		Ultra-GutterGuard®						Page 88
Item #	Description	Size	Units/Pkg.	Absorbs/Pkg. (gal.)	Qty./Pallet	Compatibility	Incinerable?	Page #
ULT9217	Ultra-DrainGuard® Oil & Sediment	48"L x 36"W x 18"H	1	n/a	36	W, O	no	88
ULT9218	Ultra-DrainGuard® Oil & Sediment	48"L x 36"W x 18"H	10	n/a	20	W, O	no	88

Ultra-Spill Decks®		Ultra-Spill Decks®						Page 90
Item #	Description	Size	Load Capacity	Sump Capacity	Qty./Pallet	Compatibility	Incinerable?	Page #
DECK1	1-Drum Section	26"L x 26"W x 5.75"H	3,000 lbs.	11.0 gal.	20	A, W, O, S	no	90
DECK2	2-Drum Section	52"L x 26"W x 5.75"H	3,000 lbs.	22.0 gal.	20	A, W, O, S	no	90
DECK4	4-Drum Section	52"L x 52"W x 5.75"H	6,000 lbs.	44.0 gal.	10	A, W, O, S	no	90
BHFIT	Bulkhead Fitting	.75" Dia.	n/a	n/a	5,000	A, W, O, S	no	90
DECKRAMP	Loading Ramp	24"L x 32"W x 5.75"H	n/a	n/a	25	A, W, O, S	no	90
T-STRIP	T-Strips	26"	n/a	n/a	5,000	A, W, O, S	no	90

Ultra-Spill Deck P1 Bladder System®		1-Drum Bladder System						Page 91
Item #	Description	Size	Load Capacity	Sump Capacity (gal.)	Qty./Pallet	Compatibility	Incinerable?	Page #
BLADDER1	1-Drum Bladder System	26"L x 30.5"W x 5.75"H	1,500 lbs.	66.0 gal.	20	A, W, O, S	no	91

IBC Spill Pallets®		IBC Spill Pallets						Page 91
Item #	Description	Size	Load Capacity	Sump Capacity (gal.)	Qty./Pallet	Compatibility	Incinerable?	Page #
IBCTWIN-ND	2-IBC w/o Drain	124.5"L x 61.625"W x 22"H	8,000 lbs.per side	535.0 gal.	1	A, W, O, S	no	91
IBCTWIN-WD	2-IBC w/ Drain	124.5"L x 61.625"W x 22"H	8,000 lbs.per side	535.0 gal.	1	A, W, O, S	no	91
IBC-ND	1-IBC w/o Drain	62"L x 62"W x 28"H	8,500 lbs.	360.0 gal.	1	A, W, O, S	no	91
IBC-WD	1-IBC w/ Drain	62"L x 62"W x 28"H	8,500 lbs.	360.0 gal.	1	A, W, O, S	no	91
IBCSHELF	Bucket Shelf	19.5"L x 16"W x 14.5"H	n/a	3.0 gal.	20	A, W, O, S	no	91

Ultra-SpillPallets® / Economy Model		Ultra-Spill Pallets® / Economy Model						Page 91
Item #	Description	Size	Units/Package	Load Capacity	Sump Cap. (gal.)	Qty./Pallet	Compatibility	Page #
PALLET2-WD	2-Drum w/ Drain	53"L x 29"W x 16.5"H	1	1,500 lbs.	66.0 gal.	5	A, W, O, S	91
PALLET2-ND	2-Drum w/o Drain	53"L x 29"W x 16.5"H	1	1,500 lbs.	66.0 gal.	5	A, W, O, S	91
PALLET4-WD	4-Drum w/ Drain	53"L x 53"W x 11.75"H	1	3,000 lbs.	66.0 gal.	7	A, W, O, S	91
PALLET4-ND	4-Drum w/o Drain	53"L x 53"W x 11.75"H	1	3,000 lbs.	66.0 gal.	7	A, W, O, S	91
PALLETRAMP	Loading Ramp	68.5"L x 28.5"W x 12"H	1	n/a	n/a	10	A, W, O, S	91

Drum Roll Top Hardcovers		Drum Roll Top Hardcovers						Page 92
Item #	Description	Size	Load Capacity	Sump Capacity (gal.)	Qty./Pallet	Compatibility	Incinerable?	Page #
HARDTOP4-WD	4-Drum w/ Drain	64.5"L x 62"W x 79"H	9,000 lbs.	75.0 gal.	1	A, W, O, S	no	92
NEW HARDTOP4-ND	4-Drum without Drain	64.5"L x 62"W x 79"H	9,000 lbs.	75.0 gal.	1	A, W, O, S	no	92
HARDTOP2-WD	2-Drum w/ Drain	67.25"L x 41.25"W x 74"H	4,500 lbs.	66.0 gal.	1	A, W, O, S	no	92
NEW HARDTOP2-ND	2-Drum without Drain	67.25"L x 41.25"W x 74"H	4,500 lbs.	66.0 gal.	1	A, W, O, S	no	92
HTRAMP	Loading Ramp	46"L x 28"W x 8.75"H	n/a	n/a	10	A, W, O, S	no	92

IBC Hard Tops		IBC Hard Tops						Page 92
Item #	Description	Size	Load Capacity	Sump Capacity (gal.)	Qty./Pallet	Compatibility	Incinerable?	Page #
NEW IBCHT-WD	IBC w/ Drain	64.5"L x 62"W x 96"H	8,500 lbs.	360.0 gal.	1	A, W, O, S	no	92
NEW IBCHT-ND	IBC without Drain	64.5"L x 62"W x 96"H	8,500 lbs.	360.0 gal.	1	A, W, O, S	no	92

Poly-Rack System		Poly-Rack System						Page 93
Item #	Description	Size	Units/Package	Load Capacity	Sump Capacity (gal.)	Qty./Pallet	Compatibility	Page #
ENP6000	Poly Racker	49"L x 23"W x 53"H	1	3,000 lbs.	103.0 gal.	4	n/a	93
ENP6002	Poly Stacker	49"L x 41"W x 13"H	1	2,400 lbs.	n/a	7	n/a	93
ENP6003	Poly Shelf	17"L x 22"W x 17.5"H	1	60 lbs.	n/a	16	n/a	93

Poly-Dolly® Portable Dispensing Station		Poly-Dolly						Page 93
Item #	Description	Size	Units/Package	Load Capacity	Sump Capacity (gal.)	Qty./Pallet	Compatibility	Page #
ENP5300	Poly-Dolly®	69"L x 32.5"W x 26.5"H	1	600 lbs.	80.0 gal.	1	A, W, O, S	93

Containment Sumps		Containment Sumps						Page 93
Item #	Description	Size	Load Capacity	Sump Capacity (gal.)	Qty./Pallet	Compatibility	Incinerable?	Page #
SUMP550-WD	550 Sump w/ Drain	87"L x 62.25"W x 32.75"H	n/a	605.0 gal.	6	n/a	no	93
NEW SUMP550-ND	550 Sump without Drain	87"L x 62.25"W x 32.75"H	n/a	605.0 gal.	6	n/a	no	93
SUMP275-WD	275 Sump w/ Drain	84.5"L x 43.75"W x 29"H	n/a	360.0 gal.	6	n/a	no	93
NEW SUMP275-ND	275 Sump without Drain	84.5"L x 43.75"W x 29"H	n/a	360.0 gal.	6	n/a	no	93

Funnel/Poly-Collector™ / Dolly		Funnel/Poly-Collector™ / Dolly						Page 94
Item #	Description	Size	Units/Package	Load Capacity	Sump Capacity (gal.)	Qty./Pallet	Compatibility	Page #
NEW FNL100	Universal Poly-Drum Funnel	23.6"Dia. x 5.5"H	1	n/a	n/a	30	A, W, O, S	94
ENP8075	Poly-Collector™	32.5"Dia. x 31"H	1	n/a	66 gal.	Stack of 5	A, W, O, S	94
ENP8050	Drum Dolly	27.5"Dia. x 5.5"H	1	n/a	n/a	50	A, W, O, S	94

Ultra Burp-Free Funnels		Burp-Free Funnels						Page 94
Item #	Description	Size	Units/Pkg.	Weight/Pkg	Qty./Pallet	Compatibility	Incinerable?	Page #
FUNNEL-S	Funnel	13.375" Dia. x 11"H	1	6 lbs.	40	A, W, O, S	no	94
FUNNEL-L	Large-Diameter Funnel	22" Dia. x 11.5"H	1	8 lbs.	20	A, W, O, S	no	94

Poly-Edge®		Poly-Dolly						Page 95
Item #	Description	Size	Load Capacity	Sump Capacity (gal.)	Qty./Pallet	Incinerable?	Compatibility	Page #
ENP1601	Poly-Edge®	34.75"L x 20"W x 15"H	1	20.0 gal.	18	No	A, W, O, S	95

Utility Trays		Utility Trays						Page 95
Item #	Description	Size	Sump Capacity (gal.)	Units/Pkg.	Qty./Pallet	Compatibility	Incinerable?	Page #
NEW TRAY4048	Utility Tray	40"L x 48"W x 3.5"H	30.0 gal.	1	15	A, W, O, S	no	95
NEW TRAY3636	Utility Tray	36"L x 36"W x 4.75"H	27.0 gal.	1	15	A, W, O, S	no	95
NEW TRAY3048	Utility Tray	30"L x 48"W x 4.75"H	30.0 gal.	1	15	A, W, O, S	no	95
NEW TRAY2448	Utility Tray	24"L x 48"W x 4.75"H	24.0 gal.	1	15	A, W, O, S	no	95
NEW TRAY2436	Utility Tray	24"L x 36"W x 4.75"H	18.0 gal.	1	15	A, W, O, S	no	95
NEW TRAY1248	Utility Tray	12"L x 48"W x 4.75"H	12.0 gal.	1	24	A, W, O, S	no	95

Build Your Own Berm		Build Your Own Berm						Page 97
Item #	Description	Size	Units/Pkg.	Absorbs/Pkg. (gal.)	Qty./Pallet	Compatibility	Incinerable?	Page #
BYOB-KIT	BYOB Kit	60"L x 5.5"W x 2"H	1	n/a	12	W, O, S	no	97
BYOB-2S	BYOB Straight Section	15"L x 5.5"W x 2"H	1	n/a	24	W, O, S	no	97
BYOB-2C	BYOB Corners	7.25"L x 5.5"W x 2"H	2	n/a	230	W, O, S	no	97
BYOB-2WE	BYOB Wall Ends	3"L x 5.5"W x 2"H	2	n/a	230	W, O, S	no	97
BYOB-SEAL	Sili-Thane Sealant	2" Dia. x 11.25"H	6	n/a	72	W, O, S	no	97
BYOB-CEMENT	BYOB Cement	8 oz.	1	n/a	100	W, O, S	no	97

Drive-Over Build Your Own Berm		Drive-Over Build Your Own Berm						Page 97
Item #	Description	Size	Units/Pkg.	Absorbs/Pkg. (gal.)	Qty./Pallet	Compatibility	Incinerable?	Page #
DOBYOB-2S	DOBYOB Straight Section	12"L x 5.5"W x 2"H	1	n/a	32	W, O, S	no	97
DOBYOB-2VC	DOBYOB Vented Corners	11.25"L x 5.5"W x 2"H	2	n/a	264	W, O, S	no	97
DOBYOB-2WE	DOBYOB Wall Ends	3"L x 5.5"W x 2"H	2	n/a	260	W, O, S	no	97
BYOB-SEAL	Sili-Thane Sealant	2" Dia. x 11.25"H	6	n/a	72	W, O, S	no	97
BYOB-CEMENT	BYOB Cement	8 oz.	1	n/a	100	W, O, S	no	97

SpillPal™ Portable Spill Containment		SpillPal™ Portable Spill Containment						Page 98
Item #	Description	Size	Units/Package	Load Capacity	Sump Cap. (gal.)	Qty./Pallet	Compatibility	Page #
SPAL1	1-Drum SpillPal™	2'L x 2'W x 3"H	1	n/a	7.5 gal.	48	n/a	98
SPAL2	2-Drum SpillPal™	2'L x 4'W x 3"H	1	n/a	15.0 gal.	36	n/a	98
SPAL4	4-Drum SpillPal™	4'L x 4'W x 3"H	1	n/a	30.0 gal.	28	n/a	98

Prowler™ Pools		Prowler™ Pools						Page 98
Item #	Description	Size	Units/Pkg.	Sump Capacity	Qty./Pallet	Compatibility	Incinerable?	Page #
ENP5920	Prowler™ Pool	28" Base x 13"H x 18" Opening	1	20.0 gal.	160	A, W, O, S	no	98
ENP5966	Prowler™ Pool	48" Base x 14"H x 36" Opening	1	66.0 gal.	48	A, W, O, S	no	98
ENP5900	Prowler™ Pool	48" Base x 18"H x 32" Opening	1	100.0 gal.	48	A, W, O, S	no	98
ENP5950	Prowler™ Pool	60" Base x 18"H x 44" Opening	1	150.0 gal.	60	A, W, O, S	no	98

Duck Ponds		Duck Pond						Page 99
Item #	Description	Size	Units/Package	Load Capacity	Sump Cap. (gal.)	Qty./Pallet	Compatibility	Page #
DKP2X2	Duck Pond	2'L x 2'W x 4'H	1	n/a	10.0 gal.	30	n/a	99
DKP2X3	Duck Pond	2'L x 3'W x 4'H	1	n/a	15.0 gal.	25	n/a	99
DKP4X4	Duck Pond	4'L x 4'W x 4'H	1	n/a	40.0 gal.	20	n/a	99
DKP4X6	Duck Pond	4'L x 6'W x 4'H	1	n/a	60.0 gal.	20	n/a	99

Folding Duck Ponds		Folding Duck Pond						Page 99
Item #	Description	Size	Units/Package	Load Capacity	Sump Cap. (gal.)	Qty./Pallet	Compatibility	Page #
FDKP2X3	Folding Pond	2'L x 3'W x 6'H	1	n/a	22.0 gal.	60	n/a	99
FDKP2X4	Folding Pond	2'L x 4'W x 6'H	1	n/a	30.0 gal.	60	n/a	99
FDKP4X6	Folding Pond	4'L x 6'W x 6'H	1	n/a	74.0 gal.	50	n/a	99

Containment Berms and Accessories		Drive-In Berm and Portable Containment					Pages 100-101		
Item #	Description	Size	Units/Package	Load Capacity	Sump Capacity (gal.)	Qty./Pallet	Compatibility	Page #	
GC1212	Ground Cover for 12' x 12'	12'L x 12'W	1	n/a	n/a	10	n/a	100	
GC1225	Ground Cover for 12' x 25'	12'L x 25'W	1	n/a	n/a	10	n/a	100	
GC1250	Ground Cover for 12' x 50'	12'L x 50'W	1	n/a	n/a	4	n/a	100	
TG3612	2 - Track Guards for 12' x 12'	36"L x 12'W	2	n/a	n/a	30	n/a	100	
TG3625	2 - Track Guards for 12' x 25'	36"L x 25'W	2	n/a	n/a	30	n/a	100	
TG3650	2 - Track Guards for 12' x 50'	36"L x 50'W	2	n/a	n/a	20	n/a	100	
BERM-TAPE	Containment Berm Repair Tape	5'L x 4'W	1	n/a	n/a	500	n/a	100	
BERM68E	Basic Containment Berm - L Bracket	8'L x 6'W x 1'H	1	n/a	359.0 gal.	12	n/a	101	
BERM1212E	Basic Containment Berm - L Bracket	12'L x 12'W x 1'H	1	n/a	1,077.0 gal.	8	n/a	101	
BERM1250E	Basic Containment Berm - L Bracket	12'L x 50'W x 1'H	1	n/a	4,488.0 gal.	4	n/a	101	
BERM48L	Premium Containment Berm - L Bracket	8'L x 4'W x 1'H	1	n/a	239.0 gal.	10	n/a	101	
BERM88L	Premium Containment Berm - L Bracket	8'L x 8'W x 1'H	1	n/a	478.0 gal.	10	n/a	101	
BERM1212L	Premium Containment Berm - L Bracket	12'L x 12'W x 1'H	1	n/a	1,077.0 gal.	8	n/a	101	
BERM1225L	Premium Containment Berm - L Bracket	12'L x 25'W x 1'H	1	n/a	2,244.0 gal.	6	n/a	101	
BERM1250L	Premium Containment Berm - L Bracket	12' L x 50'W x 1'H	1	n/a	4,488.0 gal.	4	n/a	101	
BERM68FE	Containment Berm - Foam Wall - Economy	6' L x 8'W x 4"H	1	n/a	120.0 gal.	8	n/a	101	
BERM1212FE	Containment Berm - Foam Wall - Economy	12' L x 12'W x 4"H	1	n/a	359.0 gal.	6	n/a	101	
BERM1212FC	Containment Berm - Foam Wall - Coolguard	12' L x 12'W x 4"H	1	n/a	359.0 gal.	6	n/a	101	
BERM1225FE	Containment Berm - Foam Wall - Economy	12' L x 25'W x 4"H	1	n/a	748.0 gal.	4	n/a	101	
BERM1225FC	Containment Berm - Foam Wall - Coolguard	12' L x 25'W x 4"H	1	n/a	748.0 gal.	4	n/a	101	
BERM1250FE	Containment Berm - Foam Wall - Economy	12' L x 50'W x 4"H	1	n/a	1,496.0 gal.	2	n/a	101	
BERM1250FC	Containment Berm - Foam Wall - Coolguard	12' L x 50'W x 4"H	1	n/a	1,496.0 gal.	2	n/a	101	
PAC1212	Containment Berm	12'L x 12'W x 12"H	1	n/a	1,077.0 gal.	1	A, W, O, S	101	
PAC1225	Containment Berm	25'L x 12'W x 12"H	1	n/a	2,244.0 gal.	1	A, W, O, S	101	
PAC1250	Containment Berm	50'L x 12'W x 12"H	1	n/a	4,488.0 gal.	1	A, W, O, S	101	

Product Information - All information provided about SpillTech® Products is based upon testing and data believed to be accurate. However, the reliability of this information is not subject to any guarantee.

Handling and Disposal - Liquids absorbed by SpillTech® Products are not rendered less hazardous, less toxic or less flammable by absorption; liquids remain in their original states. Therefore, caution in the handling, storage, disposal or cleaning of SpillTech® Products after use should be in accordance with the original liquids absorbed. Consult the Material Safety Data Sheet of each liquid absorbed for proper handling. SpillTech® Products must be transported and disposed of in compliance with local, state and federal regulations. SpillTech does not recommend specific procedures due to variances in regulations, applications and liquids used.

Warranty - SpillTech will replace any product found to be defective in material or workmanship. This warranty shall only apply where the buyer has issued written notice to SpillTech within thirty (30) days of purchase; it does not extend to product abuse, misuse, neglect or accident, nor to product repaired or altered by any other than SpillTech. This warranty is exclusive and in lieu of all other warranties, expressed or implied.

Limitation of Liability - In no event will SpillTech's liability for its Products exceed the purchase price paid for its Products. SpillTech will not be liable under any circumstances for any special, indirect, consequential, or punitive damages, including, but not limited to loss of profits, loss of business opportunities, or loss of goodwill, even if advised of the possibility of such damages.

Floor Grabber™ Mats Notice: Floor Grabber™ Mats are formulated to work with most common industrial and commercial floor surfaces but are not intended for home/residential use and wood flooring. All adhesive mats have some potential to leave residue or lift or discolor finish coatings, paint, and loose or predamaged tiles depending on the condition and age of the floor surface. If you have questions about the suitability of Floor Grabber™ Mats for your application, test a 6" x 6" piece in a noncritical area before use. Floor Grabber™ Mats should be replaced if they become saturated or show signs of wear or damage.

CUSTOMER ASSUMES THE RISK THAT FLOOR GRABBER™ MATS MAY DAMAGE OR ALTER CUSTOMER'S EXISTING FLOORING OR FLOOR COVERING. SPILLTECH PROVIDES NO WARRANTY OF FITNESS FOR A PARTICULAR PURPOSE AND NO WARRANTY THAT THE USE OF FLOOR GRABBER™ MAT WILL BE ACCEPTABLE FOR USE IN THE CUSTOMER'S FACILITY. SPILLTECH SHALL HAVE NO RESPONSIBILITY FOR, AND CUSTOMER HEREBY RELEASES AND DISCHARGES SPILLTECH FROM, ANY DIRECT, INDIRECT, INCIDENTAL OR CONSEQUENTIAL DAMAGES TO CUSTOMER'S FLOORS, FLOORING MATERIAL, OR ANY OTHER SURFACES IN CUSTOMER'S FACILITY. CUSTOMER IS SOLELY RESPONSIBLE FOR DETERMINING THE FITNESS AND APPROPRIATENESS OF THE USE OF A SPILLTECH FLOOR GRABBER™ MAT IN CUSTOMER'S FACILITY.

Item Number Index

Need to find a product by its item number? Look it up fast with this easy-to-use alphanumeric index.

ITEM#	PAGE#	ITEM#	PAGE#	ITEM#	PAGE#
A					
A-APRON-WH.....	81	ADC36-R.....	87	C-BOOM18-50.....	41
A-BLACKBAG.....	73, 79	ADC42-CASE.....	87	C-BOOM24-100.....	41
A-COVER-LG.....	83	ADC42-R.....	87	C-BOOM24-50.....	41
A-COVER-SM.....	83	ADC48-R.....	87	CCS040.....	21
A-DISPBAG.....	84	ANS1.....	47, 82	CELL30.....	23
A-DISPBAG-ROLL.....	84	ANS12.....	47	CLAY32.....	23
A-DISPBAG-SM.....	84	ANS5.....	47	COB40.....	23
A-DUFFLE.....	73, 79	APMPM.....	40		
A-EGB.....	84	APMPM-R.....	40		
A-EPOXY.....	82				
A-EPOXY-CS.....	82	B			
A-GLV-NEO.....	82	BAN1.....	47	DECK1.....	90
A-GLV-NIT.....	82	BAN12.....	47	DECK2.....	90
A-GLV-NIT-CS.....	82	BERM-TAPE.....	100	DECK4.....	90
A-GOG.....	81	BERM1212E.....	101	DECKRAMP.....	90
A-GTOTE.....	74, 79	BERM1212FC.....	101	DKP2X2.....	99
A-KADDIE.....	67, 79	BERM1212FE.....	101	DKP2X3.....	99
A-KITLABEL.....	84	BERM1212L.....	101	DKP4X4.....	99
A-LATEXBOOTS.....	81	BERM1225L.....	101	DKP4X6.....	99
A-LIGHTSTICKS.....	83	BERM1225FC.....	101	DOBYOB-2S.....	97
A-MAGRACK.....	20	BERM1225FE.....	101	DOBYOB-2VC.....	97
A-MASK.....	81	BERM1250E.....	101	DOBYOB-2WE.....	97
A-OBAG.....	79	BERM1250FC.....	101	DP2.....	87
A-PADBOX.....	49	BERM1250FE.....	101	DP3.....	87
A-PHTEST.....	83	BERM1250L.....	101	DP4.....	87
A-PND.....	82	BERM48L.....	101	DP6.....	87
A-ROLLRACK2.....	49	BERM68E.....	101	DPO-16.....	37
A-SEAL.....	84	BERM68FE.....	101	DPU-16.....	22
A-SHOVNS.....	84	BERM88L.....	101		
A-TYVEK-L.....	81	BHFIT.....	90		
A-TYVEK-XL.....	81	BLADDER1.....	91	E	
A-UTILITYBOX5.....	70, 79	BN1.....	48	ENP1601.....	95
A-UTILITYBOX8.....	70, 79	BN6.....	48	ENP5300.....	93
A-WASTE.....	84	BPF100H.....	31	ENP5900.....	98
A-WCAB.....	76, 79	BPF100H-BX.....	31	ENP5920.....	98
A-WOODPLUGS-LG.....	82	BPF200S.....	31	ENP5950.....	98
A-WOODPLUGS-SM.....	82	BPL100H.....	33	ENP5966.....	98
A-WRINGER.....	49	BRF150H.....	31	ENP6000.....	93
A-YBAG.....	79	BTOP.....	36	ENP6002.....	93
A-YTOTE.....	75, 79	BYOB-2C.....	97	ENP6003.....	93
A10DRUM.....	66, 80	BYOB-2S.....	97	ENP8050.....	94
A20OVER.....	66, 77, 80	BYOB-2WE.....	97	ENP8075.....	94
A20OVER-HV.....	69	BYOB-CEMENT.....	97		
A30OVER.....	66, 80	BYOB-KIT.....	97		
A30OVER-HV.....	69	BYOB-SEAL.....	97		
A50CAN-WD.....	67, 80				
A50OVER-WD.....	65, 80	C			
A55DRUM.....	65, 80	C-ANCHOR2.....	41	FDKP2X3.....	99
A50OVER.....	76, 80	C-BOOM10-100.....	41	FDKP2X4.....	99
A65OVER.....	65, 80	C-BOOM10-50.....	41	FDKP4X6.....	99
A65OVER-HV.....	69	C-BOOM18-100.....	41	FL1.....	23
A95OVER.....	64, 80			FL12.....	23
A95OVER-HV.....	69			FLKIT.....	77
A95OVER-RC.....	80				
A95OVER-WD.....	64, 80				
ADC12-CIR.....	87				
ADC36-CASE.....	87				

ITEM#	PAGE#
FLKIT1	77
FNL100	94
FUNNEL-L	94
FUNNEL-S	94

G

GB510SN	22
GC1212	100
GC1225	100
GC1250	100
GCS01210	21
GCS0410	21
GCS0430	21
GCS0815	21
GNPF100H	11
GNPF100H-BX	11
GNPF100M	11
GNRF150H	11
GNRSF150H	11
GP-H	7
GP-M	7
GP-S	7
GPB100H	9
GPB100M	9
GPB100S	9
GPB200S	9
GPB50H	9
GPB50M	9
GPC100S	17
GPC75H	17
GPF100H	11
GPF100H-BX	11
GPF100M	11
GPF1014H	11, 83
GPF200S	11
GPF20S	11
GPIL1010	22
GPIL1224	22
GPIL1818	22
GPIL818	22
GPKB50H	9
GPKF50H	11
GPL100H	13
GPL100M	13
GR-H	7
GR-M	7
GRB150H	9
GRB150M	9
GRB300S	9
GRC150H	17
GRC150S	17
GRF100H-BX	11
GRF150H	11
GRF150M	11
GRF24150H	11

ITEM#	PAGE#
GRF300S	11
GRFF50H	11
GRL150H	13
GRL150M	13
GRSB150H	9
GRSF150H	11
GRSF150M	11
GRSF1550S	11, 20
GRSF300S	11
GRSL150H	13
GRSL150M	13
GRSMF100H-BX	19
GTOP	19

H

HARDTOP2-ND	92
HARDTOP2-WD	92
HARDTOP4-ND	92
HARDTOP4-WD	92
HFN1	48
HFN6	48
HTRAMP	92
HZ510SN	46
HZ810SN	46

I

IBC-ND	91
IBC-WD	91
IBCSHELF	91
IBCTWIN-ND	91
IBCTWIN-WD	91
IBCHT-ND	92
IBCHT-WD	92

L

LD1010	85
LD1818	85
LD55	85
LDHOSE	85
LDSTRAPS	85

M

MERC-KIT2	77
MPN-KIT	48
MR1020	23
MR2069	56
MR8014	86
MR8018	86
MR8019	86

N

NPR150H-GR	56
NPR300S-GR	56
NPRR36H	57
NPRR72H	57
NRT100S-BK	53
NRT100S-GY	53
NRT100S-HV	53
NRT10S-BK	53
NRT10S-GY	53
NRT24100S-BK	53
NRT24100S-GY	53
NRT25H-GY	55
NRT50S-BK	53
NRT50S-GY	53
NRT5S-BK	53
NRT5S-GY	53

P

PAC1212	101
PAC1225	101
PAC1250	101
PALLET2-ND	91
PALLET2-WD	91
PALLET4-ND	91
PALLET4-WD	91
PALLETRAMP	91
PBL253	86
PBR100	56
PEAT2	40
PPE-KIT	77
PREM510	38
PREM810	38

R

RIG160H	36
RRMAT19	58
RRMAT60	58
RRUG18H	57
RRUG36H	57
RSPKHZ-10	66
RSPKHZ-20	66, 69
RSPKHZ-30	66, 69
RSPKHZ-50	65
RSPKHZ-55	65
RSPKHZ-65	65, 69
RSPKHZ-95	64, 69
RSPKHZ-CAN	67
RSPKHZ-CART	70
RSPKHZ-KAD	67
RSPKO-10	66
RSPKO-20	66, 69
RSPKO-30	66, 69
RSPKO-50	65
RSPKO-55	65
RSPKO-65	65, 69
RSPKO-95	64, 69
RSPKO-CAN	67
RSPKO-CART	70
RSPKO-KAD	67
RSPKU-10	66
RSPKU-20	66, 69
RSPKU-30	66, 69
RSPKU-50	65
RSPKU-55	65
RSPKU-65	65, 69
RSPKU-95	64, 69
RSPKU-CAN	67
RSPKU-CART	70
RSPKU-KAD	67

S

SPAL1	98
SPAL2	98
SPAL4	98
SPB10C	86
SPKHZ-10	66
SPKHZ-20	66
SPKHZ-20-HV	69
SPKHZ-30	66
SPKHZ-30-HV	69
SPKHZ-5	76
SPKHZ-50-WD	65
SPKHZ-55	65
SPKHZ-65	65
SPKHZ-65-HV	69
SPKHZ-95	64
SPKHZ-95-HV	69

SPILLTECH PRODUCTS CAN HELP YOU COMPLY

HYC

Look for this symbol throughout the catalog for Products that Help You Comply with federal regulations.

Below you'll find brief summaries of the regulations encountered most often by SpillTech customers, along with a list of relevant SpillTech Products that can help you

comply. For full information on specific compliance requirements, please refer to the Code of Federal Regulations at: www.gpoaccess.gov/cfr/index.html.

29 CFR – OSHA (Occupational Health & Safety Administration)

SpillTech Products that Help You Comply: Mats & Sorbents (see pages 6–58) • OverPacks & Spill Kits (see pages 63–84)

29 CFR 1910.22(a)(2)

SUMMARY: Floors in your workplace should be “maintained in a clean and, so far as possible, a dry condition.”

29 CFR 1910.107(b)(3)

SUMMARY: Combustible floors in a spray booth or work area “shall be covered with noncombustible material to facilitate the safe cleaning and removal of residues.”

29 CFR 1910.107(g)(2)

SUMMARY: OSHA requires spraying areas to be “kept as free from the accumulation of deposits of combustible residues as practical.”

29 CFR 1910.120(j)(1)

SUMMARY: Commonly known as HAZWOPER, requires DOT containers and proper absorbents be kept available and used wherever spills, leaks or ruptures may occur.

29 CFR 1910.1450(e)

SUMMARY: OSHA requires containment and cleanup materials for spills in laboratories to reduce occupational exposure to hazardous chemicals.

33 CFR – USCG (United States Coast Guard)

SpillTech Products that Help You Comply: Booms • PomPoms • Net Bags • Sweeps (see pages 38–39, 40-41)

33 CFR 154.1047(c)(2)

SUMMARY: Concerning navigation and navigable waters, a facility which handles, stores or transports Group V

petroleum oils must identify response plan resources such as containment booms or other methods.

40 CFR – EPA (Environmental Protection Agency)

SpillTech Products that Help You Comply: Spill Kits (see pages 63–84) • Berms & DrainCovers (86–88) • SpillPallets (90-92, 95)

40 CFR 112.7(c)(1)

SUMMARY: Facilities must have “appropriate containment and/or diversionary structures to prevent discharge oil from reaching a navigable water course.”

40 CFR 122.26

SUMMARY: Facilities must have a detailed plan in place to prevent illegal discharge of pollutants into waterways.

40 CFR 263.30(a)

SUMMARY: Requires immediate action, such as diking the discharge area, by transporter if hazardous waste is accidentally discharged during transportation.

40 CFR 263.31

SUMMARY: A transporter must clean up any hazardous waste discharges that occur during transportation.

40 CFR 264.175

SUMMARY: A hazardous waste container must not sit in its own spill, and it must be able to hold 10% of total volume of liquid or 100% of largest container, whichever is greater.

49 CFR – DOT (Department of Transportation)

SpillTech Products that Help You Comply: OverPacks (see pages 80)

49 CFR 173.3(c)(2)

SUMMARY: If a container of hazardous waste is damaged or leaking, it can be placed in a compatible salvage drum that meets UN criteria for shipping by air, highway, rail or water.

49 CFR 173.12(b)

SUMMARY: A labpacking container must be “a UN 1A2 or UN 1B2 metal drum, a UN 1D plywood drum, a UN 1G fiber drum or a UN 1H2 plastic drum tested and marked for the Packing Group III performance level.”

49 CFR 173.12(b)(2)(iv)

SUMMARY: When labpacking, “Inner packagings ... must be surrounded by a chemically compatible absorbent material in sufficient quantity to absorb the total liquid contents.”



Manufacturing/Warehousing

Canada

SpillTech Canada
c/o JMS Warehousing
704 Mara Street
Point Edward, ON N7V 1X4

Cumberland

1 Front Street
Cumberland, RI 02864

Hastings

Hastings Area Industrial Park
233 Haida Avenue
Hastings, PA 16646

Houston

4730 Eastpark Drive
Houston, TX 77028

Milledgeville

143 Garrett Way
Milledgeville, GA 31061

Mobile

Brookley Aeroplex
1627 O'Donoghue Street
Mobile, AL 36615

Seattle

938 Valley Avenue NW
Bldg #5 Suite 101-B
Puyallup, WA 98371

Sales & Marketing Offices

6455 East Johns Crossing
Suite 375
Johns Creek, GA 30097



Look for SpillTech products that help you comply with Federal Regulations! See page 123.



Look for this icon throughout this book to purchase SpillTech products made from recycled materials.



Scan the QR code to view the online version of this catalog!
smartspillsolutions.com

Distributed By:

